

Electromagnetic Signatures of Human Skin in the Millimeter Wave Band 80–100 GHz

Amani Y. Owda*, Neil Salmon, and Nacer-Ddine Rezgui

Abstract—Due to changes in global security requirements attention is turning to new means by which anomalies on the human body might be identified. For security screening systems operating in the millimeter wave band anomalies can be identified by measuring the emissivities of subjects. As the interaction of millimeter waves with the human body is only a fraction of a millimeter into the skin and clothing has a small, but known effect, precise measurement of the emission and reflection of this radiation will allow comparisons with the norm for that region of the body and person category. A technique to measure the human skin emissivity in vivo over the frequency band 80 GHz to 100 GHz is developed and described. The mean emissivity values of the skin of a sample of 60 healthy participants (36 males and 24 females) measured using a 90 GHz calibrated radiometer were found to range from 0.17 ± 0.005 to 0.68 ± 0.005 . The lower values of emissivity are a result of measuring particularly thin skin on the inner wrist, volar side of the forearm, and back of hand, whereas higher values of emissivity are results of measuring thick skin on the outer wrist, dorsal surface of the forearm, and palm of hand. The mean differences in the emissivity between Asian and European male participants were calculated to be in the range of 0.04 to 0.11 over all measurement locations. Experimental measurements of the emissivity for male and female participants having normal and high body mass index indicate that the mean differences in the emissivity are in the range of 0.05 to 0.15 for all measurement locations. These results show the quantitative variations in the skin emissivity between locations, gender, and individuals. The mean differences in the emissivity values between dry and wet skin on the palm of hand and back of hand regions were found to be 0.143 and 0.066 respectively. These results confirm that radiometry can, as a non-contact method, identify surfaces attached to the human skin in tens of seconds. These results indicate a route to machine anomaly detection that may increase the through-put speed, the detection probabilities and reduce the false alarm rates in security screening portals.

1. INTRODUCTION

The detection of concealed threats on the human body in transport networks and border crossings poses an international challenge for the development of effective stand-off and portal security screening systems [1, 2]. The millimeter-wave (MMW) band is the region of the electromagnetic spectrum between the microwave and terahertz bands, covering the frequency ranges (30–300) GHz [3, 4]. With a high atmospheric transmission and little attenuation through textile materials and clothing, images can be formed of objects on persons concealed on or under their clothing [5] with high detection probability; a capability which is driving the developments of this security screening technology [6–11]. Imaging applied to security screening applications can either be achieved passively (radiometrically), where the natural thermal radiation emitted and reflected by the object is used or actively (radar), where the transmitter provides artificial MMW radiation to illuminate the subject and the image is formed from

Received 4 December 2017, Accepted 17 March 2018, Scheduled 30 March 2018

* Corresponding author: Amani Y. Owda (amani.owda@stu.mmu.ac.uk).

The authors are with the Manchester Metropolitan University, School of Engineering, Chester Street, Manchester, M1 5GD, United Kingdom.

the reflected radiation [12]. Passive millimeter wave images are free from artefacts such as speckle and glint as the illuminating radiation from the human body is spatially incoherent. This means that all regions of the human body down to the skin can be screened for concealed threats with a technology that potentially generates little or no false alarms [13].

The levels of emissivity and reflectivity are determined by the relative complex permittivity of a medium, and these have been measured for human skin in the microwave and MMW frequency bands at specific frequencies and over limited number of participants and measurement locations by using an open ended coaxial probe in contact with the human body [22, 30, 41–43]. Due to the limited measured data, different theoretical models are often used to predict the relative complex permittivity of the skin, such as the Cole-Cole model and Debye model [43–45]. These studies indicate variations in the relative complex permittivity and the reflectivity of the skin with frequency. However, none of these studies indicates that there is a well validated signature for the human skin over the whole of the MMW frequency band. Therefore, measurement and validation of the human skin signature at the MMW frequency bands is required to bridge this gap.

The key innovation in this work is in recognizing that signatures from the human body enabling regions of the body to be identified as skin (as opposed to concealed threat) are very subtle and then in designing a system to measure and characterize the skin for this purpose. These signature variations from the skin are small (down to tens of milliKelvin), with changes taking place on scale lengths of a centimeter or so. This opportunity has been overlooked until now by the security screening community, as the sensitivities of existing passive millimeter wave imagers are typically in the region of a few Kelvin and with spatial resolutions greater than one centimeter. Consequently, anyone who would have looked would not have observed these subtle effects of the skin. The development of a precisely calibrated radiometer having a radiometric sensitivity of 5.0 mK with a centimeter spatial resolution on the skin has enabled new measurements of the human body to be made, for exploitation in the field of security screening of people.

The main advantages of the technique presented in this paper are: 1) human skin signatures can be measured without exposing the human body to any type of artificial or man-made radiation, 2) radiometric sensitivity is sufficient to identify surfaces attached to the human skin such as liquid, metallic and non-metallic objects. Furthermore, materials intentionally attached to the skin, having dielectric properties identical with human skin (to achieve a false negative in a security screening system), will be identified by their differential radiation temperatures, something which an active system cannot achieve, 3) the measurements can be made in tens of seconds using a non-contact sensor with high precision, and 4) the system is free from artefacts of speckle effects and multipath problems since spatially incoherent emission is used [12, 13].

In Section 2 the experimental work for measuring the human skin emissivity is discussed. This describes the experimental setup and mathematical equations, radiometric calibration, methodology of measuring the human skin emissivity and methodology of data processing. Section 3 presents the experimental results for both genders at different measurement locations on the hand, and emissivity measurements for dry and wet skins, emissivity measurements for participants having Asian and European ethnicities, and emissivity measurements for participants having normal and high body mass indices. Section 4 discusses the implications for security screening. Section 5 discusses all experimental results, and Section 6 presents overall conclusions and recommendations for future work.

2. EXPERIMENTAL WORK

This section of the paper contains technical details about the experimental work conducted in this research. An experimental setup, with absolute calibration methodology, is introduced and discussed. A block diagram with detailed information about the methodology of data processing is presented.

2.1. Participants

Sixty healthy adult participants (36 males and 24 females) having a variety of ethnicities, ages, and body mass indices were measured in this research project. The participants have ages ranging from 20 to 67 years. The participants have a mean and a standard deviation (\pm SD) in mass: 72.5 ± 13.92 kg,

and height: 1.66 ± 0.099 m. Male group comprised: 12 Europeans, 12 Asians and 12 others of different ethnicities (American, African . . . etc). The female group consisted of 12 Europeans and 12 Asians. The ethics of the study was approved by the Ethics Committee of Manchester Metropolitan University and a written consent form was obtained from each participant.

2.2. Measurement Equipment

A radiometer measures the thermal (Planck) radiation, and for radiation frequencies below the mid-infrared band the intensity of the emission is directly proportional to the temperature of the object, enabling images to be calibrated in degrees Kelvin [14]. The level of thermal emission emitted from human skin can be measured experimentally, applying a linear calibration, using black body emission sources [15]; one at the temperature of the background, T_H and the other held at a lower temperature, T_C . For a direct detection radiometer, the system response is assumed to be linear and the output voltage of the receiver for an ambient temperature source calibration V_H is [15]:

$$V_H = \alpha (T_H + T_N) \quad (1)$$

where, α is the receiver responsivity measured in V/K , and T_N is the receiver noise temperature in K. For the liquid Nitrogen source calibration, the output voltage of the receiver V_C is [15]:

$$V_C = \alpha (T_C + T_N) \quad (2)$$

and for the human skin target, the output voltage of the receiver V_S is:

$$V_S = \alpha (T_b + T_N), \quad (3)$$

where, T_b is the radiation temperature of the human skin given by:

$$T_b = (1 - \eta) T_0 + T_s \eta \quad (4)$$

where the skin has an emissivity of η , a thermodynamic temperature of T_S , and T_0 is the background illumination temperature [16]. From Eqs. (1) to (4), and equating T_0 to T_H , the emissivity of the human skin can be expressed as [17]:

$$\eta = \frac{(V_s - V_H)(T_H - T_C)}{(T_s - T_H)(V_H - V_C)} \quad (5)$$

The minimum detectable radiation temperature variation ΔT_{\min} for a radiometer is given by the radiometer equation, namely:

$$\Delta T_{\min} = \frac{T_A + T_R}{\sqrt{Bt}} \quad (6)$$

where t is the post-detection integration time, T_R the receiver noise temperature, B the receiver bandwidth, and T_A the antenna radiation temperature, effectively the radiation temperature of the source in front of the antenna [15]. This constitutes the random uncertainty in the measurements for radiometers of this type.

Although human skin is the largest multifunctional organ in the human body, to date insufficient attention has been paid to human skin signatures over the MMW frequency band for security screening purposes. A number of researchers investigated the electromagnetic response of the human skin over this band for medical purposes only [18–22]. These are useful resources to explore the capabilities for security screening by the identification of anomalies on the human body which may be suggestive of a concealed threat, which is the subject of this paper. Measurement and validation of the emissivity of human skin at MMW frequency bands is an essential requirement, to help assess the feasibility of increasing the detection probabilities and reducing the false alarm rate when screening at, for example, entrances to airport departures lounges [23]. Exploiting this in machine anomaly detection reduces the possibilities for deception in security screening portals [13, 23].

A direct detection radiometer sensitive over the frequency band 80–100 GHz was used for measuring the human skin emissivity of a sample of 60 healthy participants. The measurement equipment comprises: a horn antenna connected to a radiometer (consisting of a two-stage low-noise amplifier (type: monolithic millimeter wave integrated circuit (MMIC) LNA, gain: 20 dB; zero bias diode detector (type: MMIC wideband ZBD, power 10.0 μ W) and buffer amplifier (type: MMIC wideband buffer

amplifier, power: 20 dBm, and voltage: 5.0 V). The radiometer is connected through a coaxial cable to a digital voltmeter and through wires to a DC power supply, as illustrated in Figure 1. The W-band horn antenna (type: AS4341, manufacturer: Atlan Tec RF) has a rectangular aperture ($30 \times 25 \text{ mm}^2$) and a nominal gain of 20 dBi over the frequency band (80–100) GHz. The radiometer (type: MMIC detector, manufacturer: MMIC Solutions) has a rectangular shape and dimensions (length = 70 mm, width = 30 mm, and thickness 15 mm) and a 20 GHz radiation bandwidth and radiometric sensitivity of 5.0 mK. A digital voltmeter (type: digital voltmeter, manufacturer: Keysight Technologies) with a precision of 0.1 mV was used to measure the output voltage level of the thermal emission. This precision is responsible for a systematic measurement uncertainty in the system. The complete system, except for an opening for the subject, was enclosed in an anechoic region, made from carbon loaded absorbing foam. This prevented radiation from external sources, be it from the outdoors or other people in the environment, getting into the system to corrupt signals.

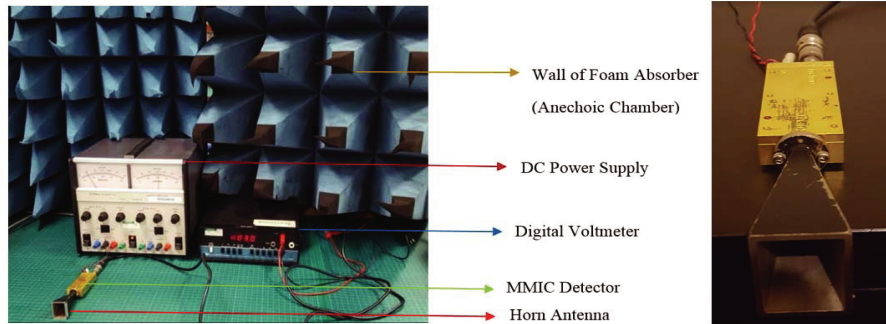

Figure 1. The main elements of the experimental work: A horn antenna connected to the MMIC detector. The detector is connected through a coaxial cable to a digital voltmeter and through wires to a DC power supply. A wall of carbon loaded absorbing foam surrounds the system.

2.3. Calibration and Initial Measurements

The radiometer was calibrated by comparing the measured data from subjects with the emission levels from known standard sources [24]. The standard sources were carbon loaded foam absorbers at liquid Nitrogen (77 K) and ambient (293 K) temperature, as illustrated in Figure 2. The cold load calibration measurements were taken within 5.0 seconds or less before the liquid Nitrogen evaporated, which is a standard measurement procedure. The carbon foam absorbers (type: Eccosorb AN-73, manufacturer: Laird) had a rectangular shape and dimensions (length = 170 mm, width = 150 mm, and thickness 10 mm). These dimensions were chosen to fill the beam pattern of the horn antenna, thereby minimizing systematic uncertainties. The measured emissivity values of the foam absorbers are greater than 0.99 over the frequency band 80–100 GHz [37–38], thus they behave as good approximations to a black body emitter. The difference in temperature between the hot and the cold load is $\sim 216 \text{ K}$, this large difference reducing the systematic uncertainties in the emissivity measurements to a minimum. The calibration Y-factor, defined as the ratio of receiver output when measuring the hot black body source to that measuring the cold source, was 1.408. These measurements were taken from ten experiments and repeated 5–10 times at each experiment, the calibration measurements were repeated 5–10 times and they were consistent. This indicates that the radiometer had a good long-term measurement stability.

The amount of self-emission reflected back from subjects was investigated by placing a metal plate perpendicular to the beam a distance 1.0 cm from the horn antenna beam. The mean level of self-emission reflected back from the metal plate (100% reflective surface) was measured to be in the range of 294–295 K with a standard deviation of $\pm 1.0 \text{ K}$. These results show that the radiation temperature from the metal plate is approximately the same as the ambient temperature, meaning there is no spurious emission from the radiometer or glint effects to corrupt measurements [25].

It is a well-known fact that the fluorescent lighting generates a low level (few Kelvin) of MMW radiation, modulated at 100 Hz, double the frequency of the mains electricity supply [25]. Millimeter-

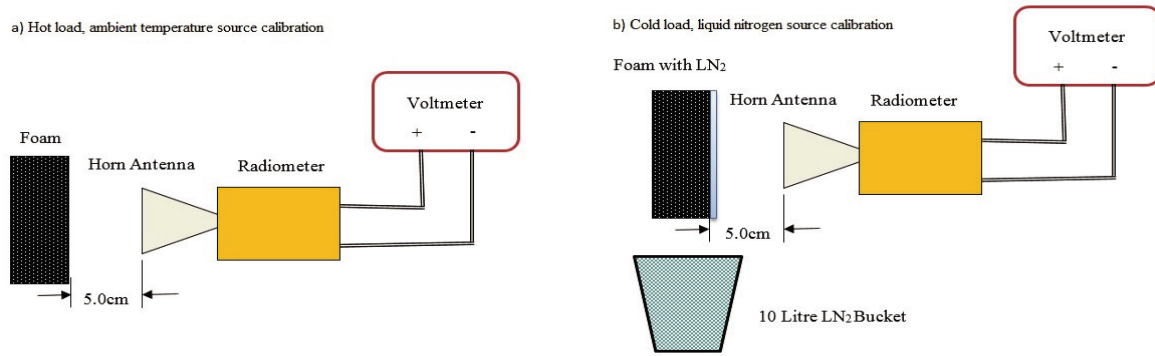

Figure 2. Ambient temperature and liquid Nitrogen calibration sources.

Wave emission emitted from a fluorescent light located ~ 5.0 cm from the horn antenna (where the measurements are conducted) was found to increase the radiation temperature measured by the radiometer by an amount 62–74 K; a mean value of 67.5 K with a standard deviation of ± 4.0 K. When the fluorescent light was located directly in the beam of the horn antenna (where the maximum increase in radiation temperature is observed), the radiation temperature was found to increase by an amount 80–100 K; a mean value of 84.3 K with a standard deviation of ± 8.0 K. For this reason, all fluorescent lights were turned off in the laboratory during the measurements.

2.4. Methodology for Measuring the Human Skin Emissivity

The horn antenna was located at a distance ~ 5.0 cm from three different radiation sources: 1) ambient temperature source calibration (see Figure 2(a)), 2) liquid Nitrogen source calibration (see Figure 2(b)) and 3) the human skin (see Figure 3). The distance 5.0 cm has been chosen as an optimal distance for an existing measurements system. This distance is chosen for convenience, to minimize the chances of subjects accidentally touching and moving the measurement apparatus. A greater distance between the measured subject and the horn antenna would lead to measurements having poorer spatial resolution. A digital voltmeter with 0.1 mV resolution was used to measure the output voltage for the target area of the skin and the calibration sources, and an infrared thermometer with absolute accuracy 0.01°C was used to measure the skin surface temperature, and the thermodynamics temperature of the calibration sources. Error propagation through Eq. (5) indicates that the systematic uncertainty is ± 0.005 , whereas error propagation from Eq. (6) indicates that the random error in the minimum detectable radiation temperature is 5.0 mK.

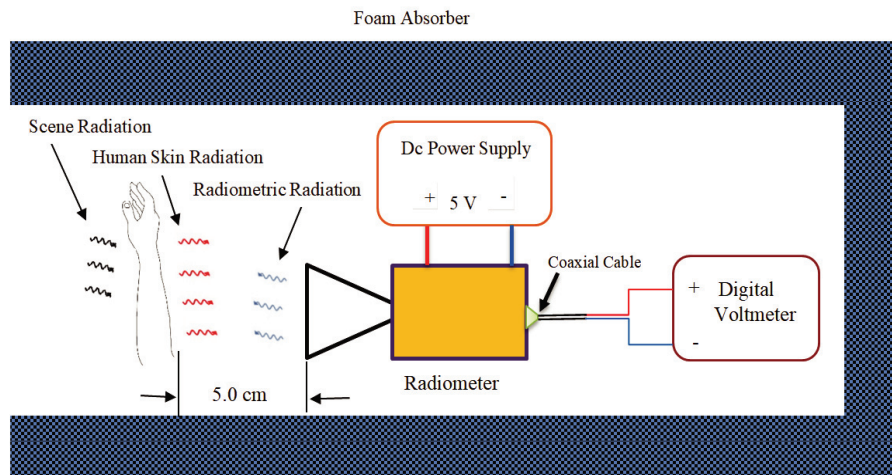

Figure 3. Experimental measurements for human skin emissivity.

The following block diagram summarizes the methodology and the statistical analysis for human skin emissivity measurement:

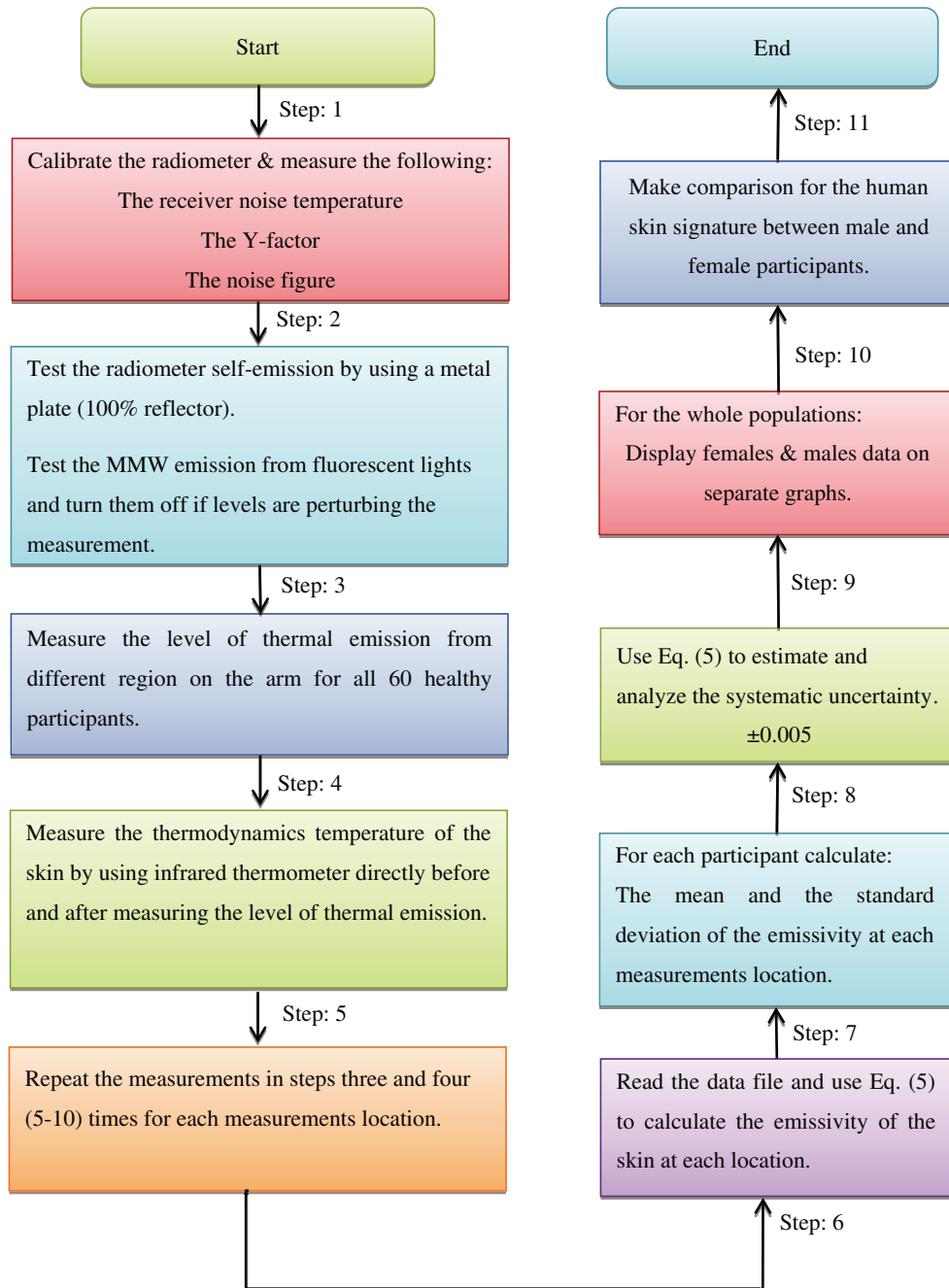

Figure 4. Methodology of data processing and statistical analysis.

3. EXPERIMENTAL RESULTS

Emissivity measurements were performed on 60 healthy participants over the frequency band 80 GHz–100 GHz. The measurements were made at six locations on the body and these were: 1) palm of hand, 2) back of hand, 3) inner wrist, 4) outer wrist, 5) volar side of the forearm, and 6) dorsal surface of the forearm as illustrated in Figure 5. These locations were chosen to provide variations in skin thickness and water content.

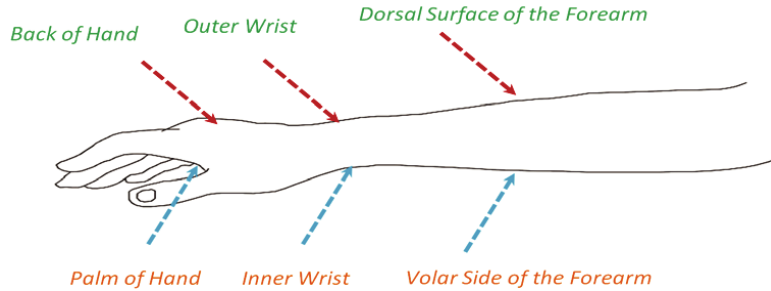

Figure 5. Six locations on the arm where the emissivity of the human skin was measured.

3.1. Male Skin Signatures

The measurements in Figures 6, 7 and 8 represent the mean emissivity for 36 male participants, with error bars representing the systematic uncertainty. The measurements show variation in emissivity between individuals and locations on the arm. These variations are due to the differences in skin thickness and the number of blood vessels (which raises the water content) which varies from one location to another and between individuals [26, 27]. The emissivity from males was found to range from 0.18 to 0.68, with mean (μ) and standard deviation (σ) for all measurement locations being 0.401 and 0.0865 respectively. In general, lower values of emissivity are a result of measuring particularly thin skin on the inner wrist, back of hand, and volar side of the forearm [27], whereas higher values of emissivity are results of measuring thick skin on the outer wrist, palm of hand, and dorsal surface of the forearm [28]. Error propagation analysis through Eq. (5) indicates that the experimental measurements uncertainty is ± 0.005 . Table 1 shows the mean, the standard deviation, and the standard error in the mean (σ/\sqrt{n} , where n is the number of participants) for a sample of 36 male participants at the six measurements locations presented in Figures 6, 7, and 8:

Table 1. Statistical analysis for emissivity measurements performed on a sample of 36 males.

Location	Mean Emissivity	Standard Deviation	Standard Error in the Mean
Outer Wrist	0.396	0.0606	0.0101
Inner Wrist	0.343	0.0639	0.0106
Palm of Hand	0.451	0.0997	0.0166
Back of Hand	0.385	0.0844	0.0140
Dorsal Surface	0.449	0.0778	0.0129
Volar Side	0.381	0.0725	0.0121

Experimental measurements in Figures 6, 7, and 8 indicate differences in the mean emissivity values between the thicker skin regions of the hand (the outer wrist, the palm of the hand and the dorsal surface of the forearm) and the thinner skin regions of the hand (the inner wrist, the back of the hand and the volar side of the forearm) for all male participants. Statistical analysis on a sample of 36 male participants indicates that the mean differences in the emissivity values between the outer and the inner wrist, the palm of the hand and the back of the hand, and the dorsal and the volar regions are: 0.0529, 0.0658 and 0.0675 with a sample standard deviation in the differences of 0.0345, 0.0531 and 0.0319 respectively. These differences are due to the skin thickness and water content (blood vessels) that varies with location and between individuals [26, 27]. The thinner skin regions with blood vessels closed to the skin surface makes the skin more reflective and this results in higher reflectance (R) and lower emissivity ($\eta = 1 - R$).

Although the emissivity measurements in Figures 6, 7, and 8 suggest possible trends related to the age of the participants, it is still too early to draw conclusions as the numbers of participants in each age category are too small. Therefore, it is recommended that further measurements needed to be conducted to address variation in emissivity with age.

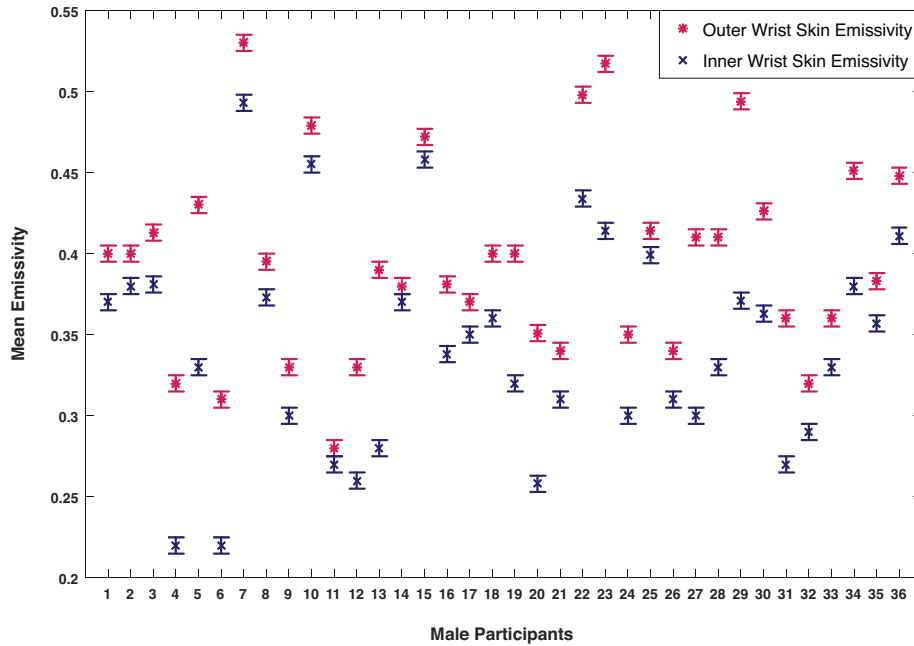

Figure 6. Mean emissivity for inner and outer wrist skin for a sample of 36 male participants. The participants’ ages are as follows:1) 20, 2) 20, 3) 21, 4) 22, 5) 22, 6) 22, 7) 23, 8) 23, 9) 23, 10) 24, 11) 24, 12) 25, 13) 26, 14) 26, 15) 26, 16) 26, 17) 27, 18) 28, 19) 29, 20) 29, 21) 30, 22) 31, 23) 31, 24) 32, 25) 34, 26) 35, 27) 37, 28) 37, 29) 40, 30) 40, 31) 42, 32) 42, 33) 45, 34) 52, 35) 58 , 36) 67.

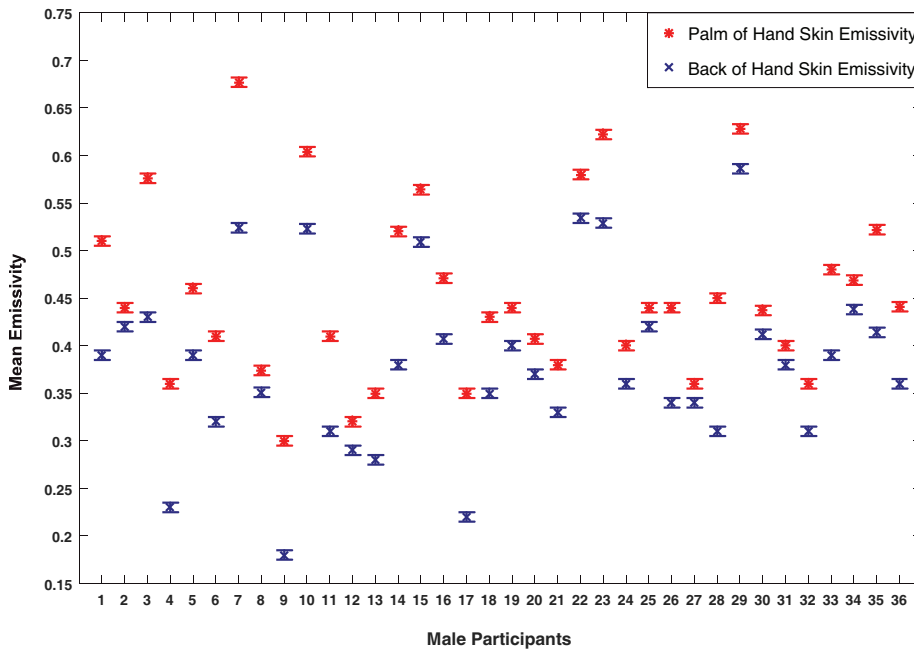

Figure 7. Mean emissivity for palm of hand and back of hand skin for a sample of 36 male participants. The participants’ ages are as in Figure 6.

3.2. Female Skin Signatures

The measurements in Figures 9, 10 and 11 represent the mean emissivity for 24 female participants, with error bars representing the systematic uncertainty. The mean emissivity of the samples over all measurement locations is 0.383 with a standard deviation of 0.0839 and experimental measurement

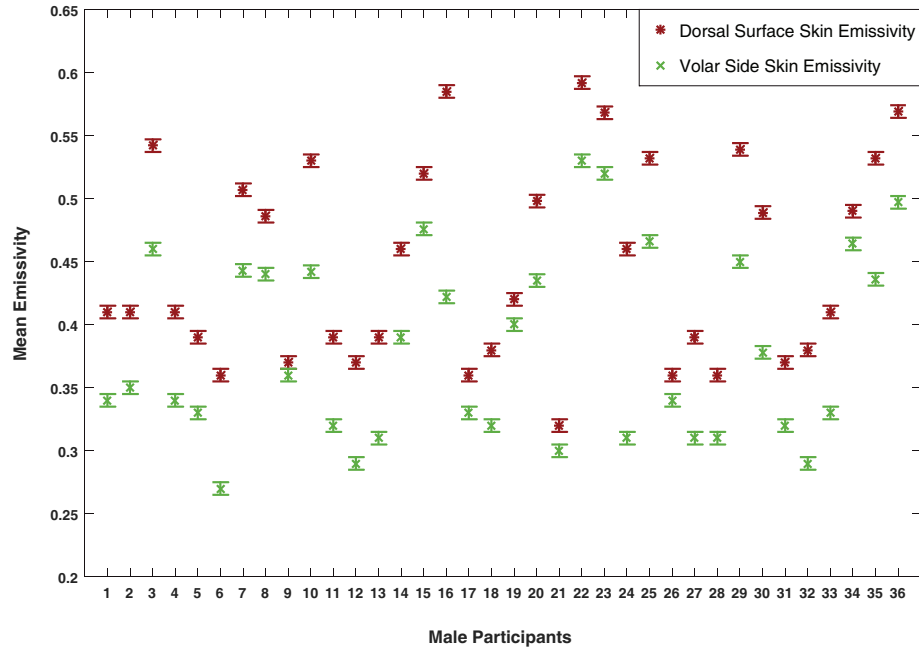

Figure 8. Mean emissivity for dorsal surface and volar side for a sample of 36 male participants. The participants’ ages are as in Figure 6.

uncertainty of ± 0.005 . Table 2 shows the mean, the standard deviation, and the standard error in the mean for a sample of 24 female participants at six measurement locations:

Table 2. Statistical analysis for emissivity measurements performed on a sample of 24 females.

Location	Mean Emissivity	Standard Deviation	Standard Error in the Mean
Outer Wrist	0.378	0.0654	0.0134
Inner Wrist	0.313	0.0620	0.0127
Palm of Hand	0.430	0.0951	0.0194
Back of Hand	0.371	0.0865	0.0177
Dorsal Surface	0.438	0.0659	0.0135
Volar Side	0.365	0.0549	0.0112

The measurements in Figures 9, 10 and 11 show a similar trend to that of the males in terms of differences in the mean emissivity values between the thicker skin region and the thinner skin region. Statistical analysis on a sample of 24 female participants indicates that the mean differences in the emissivity values between the outer and the inner wrist, the palm of the hand and the back of the hand, and the dorsal and the volar regions are: 0.0646, 0.0589 and 0.0729 with a sample standard deviation in the differences of 0.0394, 0.0375 and 0.0449, respectively.

3.3. Male and Female Skin Signatures in Dry and Wet States

In security screening, the radiometric sensitivity should be sufficient to sense different surfaces attached to the human skin such as liquid and metallic objects. With a metallic object MMW radiation has a clear signature, and this can be identified by using either active or passive MMW imaging systems. However, for the materials intentionally attached to the skin and having dielectric properties identical with human skin, a passive system can identify this anomaly by measuring radiation temperature of

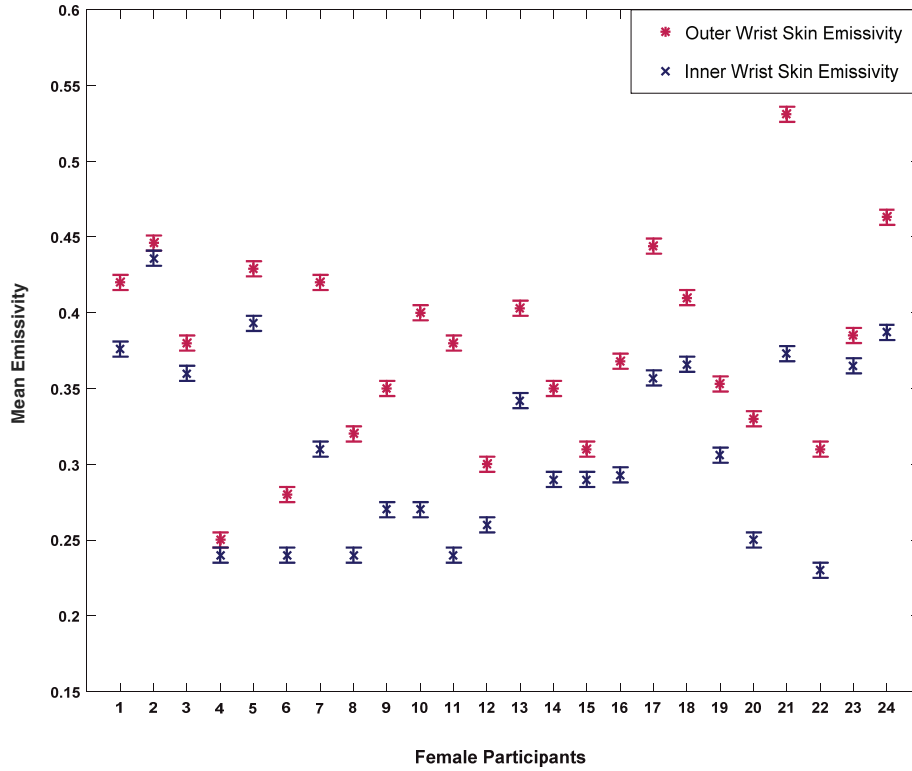

Figure 9. Mean emissivity for inner and outer wrist skin for a sample of 24 female participants. The participants' ages are as follows: 1) 22, 2) 23, 3) 23, 4) 24, 5) 24, 6) 24, 7) 25, 8) 26, 9) 27, 10) 29, 11) 29, 12) 30, 13) 31, 14) 32, 15) 32, 16) 33, 17) 33, 18) 35, 19) 36, 20) 42, 21) 44, 22) 45, 23) 45, 24) 54.

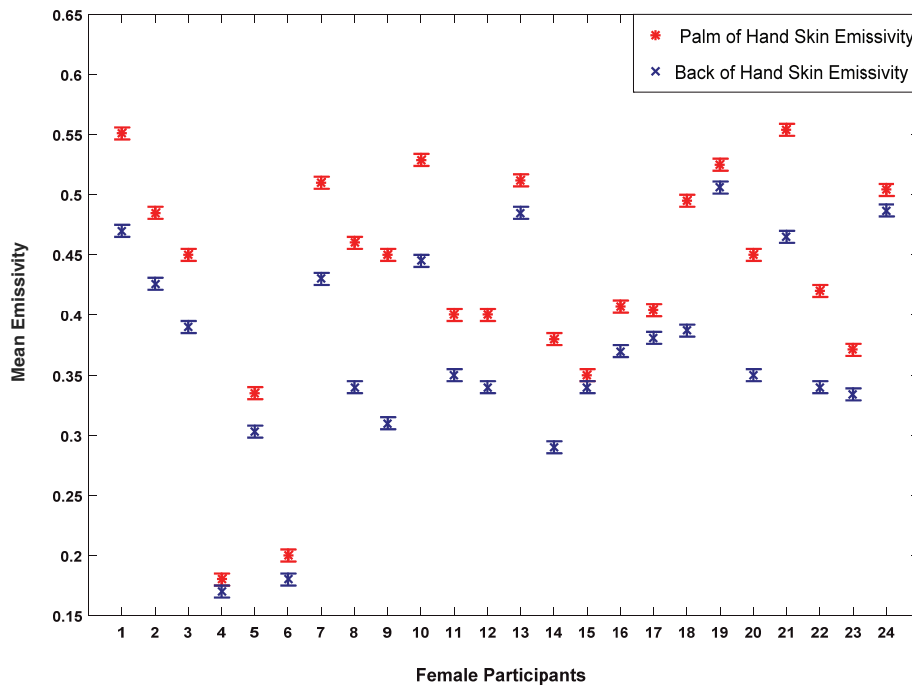

Figure 10. Mean emissivity for palm of hand and back of hand skin for a sample of 24 female participants. The participants' ages are as in Figure 9.

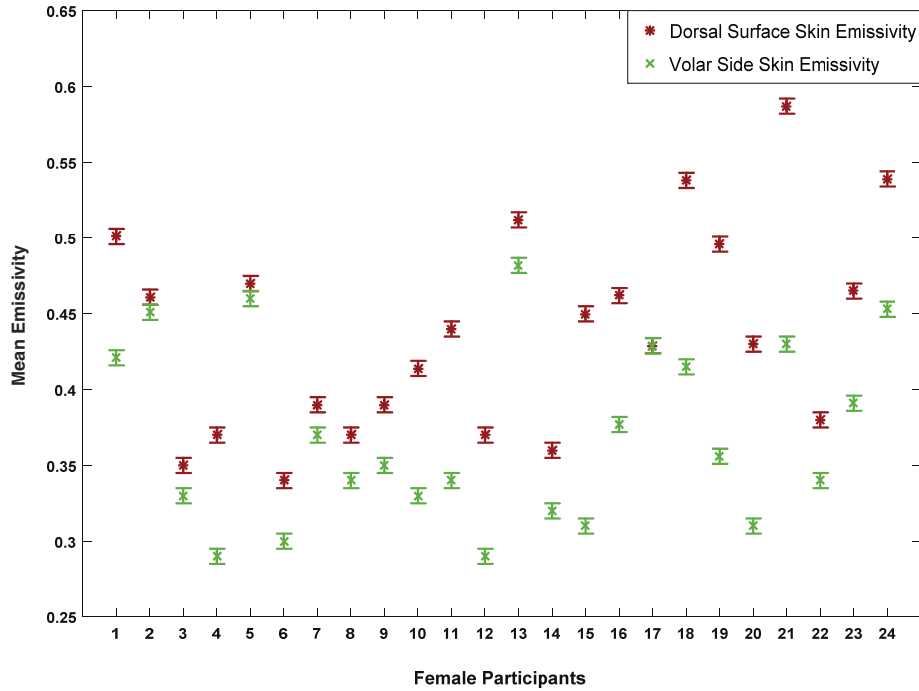

Figure 11. Mean emissivity for dorsal surface and volar side for a sample of 24 male participants. The participants’ ages are as in Figure 9.

the skin, whereas an active system will not be able to do this as it only measured reflectivity. It is a known fact that the electromagnetic properties of water dominate the electromagnetic properties of the skin over the MMW bands [29]. Therefore, this experiment investigates the ability of the radiometer to identify and sense water (H₂O) on the skin surface. The experiments were performed on 16 participants (10 males and 6 females) and on two measurement locations; the palm of the hand and the back of the hand skin. The methodology for measuring the emissivity of wet skin can be summarized as follows:

- 1) the target area of the skin was placed in a bowl of water for one minute, 2) then the hand was located on a flat surface (table) with the measurement location facing upwards for a period of 2–4 minutes until the water is absorbed, 3) then wet skin was wiped using clean and dried wipes, and 4) then the measurements were taken and repeated 5 times directly, the mean emissivity values of the palm of the hand and the back of the hand skin before and after the application of water are illustrated in Figures 12 and 13. Wet skin in this sense describes skin which has been saturated with water, but contains no surface water.

Emissivity measurements in Figure 12 for normal and wet palm of hand skin indicate differences in the mean emissivity between dry and wet skins. Statistical analysis on the data indicates that the mean difference in emissivity for the palm of the hand skin before and after wetting with water is ~ 0.143 with a sample standard deviation of ~ 0.07 , generating a standard error in the mean of 0.0175. These differences are due to the water that increases the hydration level of the skin and this makes the reflectance of the skin higher and the emissivity of the skin lower [30].

Experiment measurements in Figure 13 for normal and wet back of hand skin indicate differences in the mean emissivity between dry and wet back of hand skins. Statistical analysis on the data indicates that the mean difference in emissivity for back of hand skin before and after wetting with water is ~ 0.066 with a sample standard deviation of ~ 0.046 , generating a standard error in the mean of 0.0115. This difference is less than that of the palm of the hand skin. The thick Stratum Corneum (SC) layer on the palm of the hand region can retain water and this makes the hydration level for the palm of hand skin in wet state significantly higher than that of normal state [30], and therefore the difference between the palm of the hand skin in wet and normal states is more significant compared with the back of the hand region. Furthermore, the thickness and the ability of the SC layer to retain water vary from

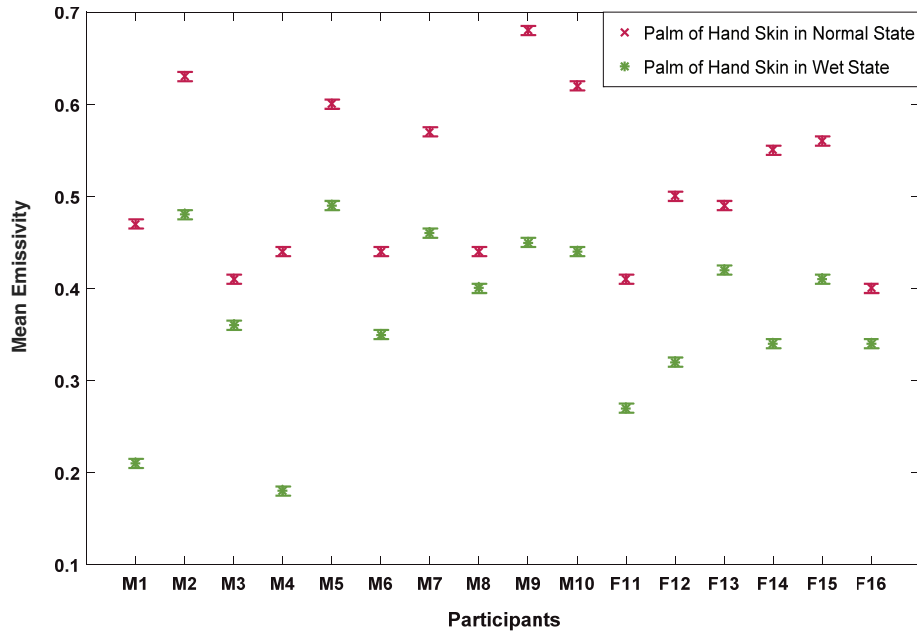

Figure 12. Emissivity measurements for normal and wet palm of hand skin performed on 10 males (M) and 6 females (F).

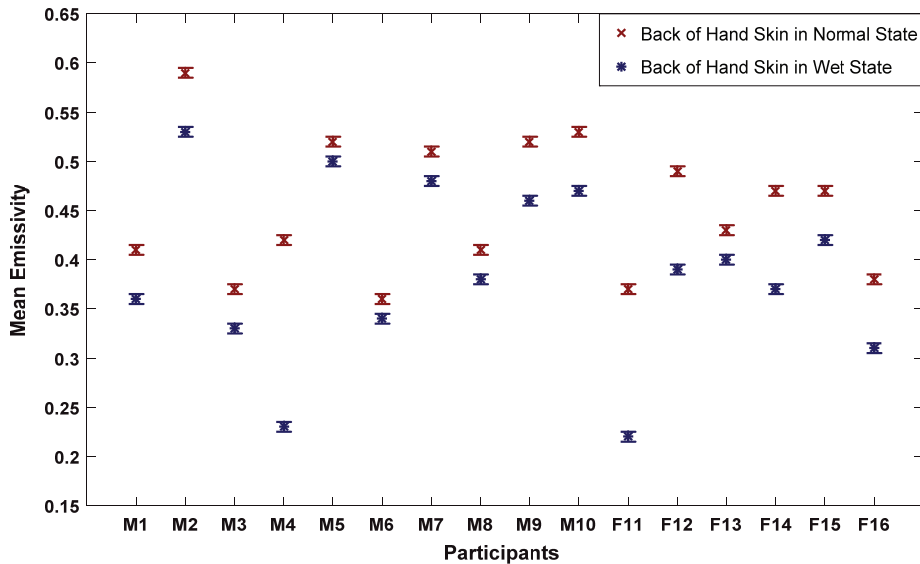

Figure 13. Emissivity measurements for dry and wet back of hand skins performed on 10 males (M) and 6 females (F).

person to person and therefore the differences between wet and normal skin vary between individuals and locations on the body.

3.4. Comparison between Male and Female Skin Signatures

Measurements of human skin emissivity of 36 male and 24 female healthy participants are presented in Table 3. The measurements show that the average of male participants' emissivity is higher than the average of the female participants' emissivity. This is consistent with the fact that male skin is thicker

than that of female skin for all ages [31–33]. This can be supported with the measurements presented in Figures 6 to 11. The measurements show that emissivity is high in the locations where the skin is thick such as; the palm of the hand, the dorsal surface of the forearm, and the outer wrist skin, and it is low in the locations where the skin is thin and the blood vessels are closer to the skin surface such as; the inner wrist, the volar side of the forearm and the back of the hand skin. These measurements show strong correlation between human skin emissivity, skin thickness and water content. This opens a new window of research in security screening, this being the identification of boundaries and limits for the emissive and reflective properties of different parts of the human body, as a means to anomaly identification.

Table 3. Mean emissivity values for male and female participants on all measurements locations.

Location	Mean Emissivity (Males)	SD (Males)	Mean Emissivity (Females)	SD (Females)
Outer Wrist	0.396	0.0606	0.378	0.0654
Inner Wrist	0.343	0.0639	0.313	0.0620
Palm of Hand	0.451	0.0997	0.430	0.0951
Back of Hand	0.385	0.0844	0.371	0.0865
Dorsal Surface	0.449	0.0778	0.438	0.0659
Volar Side	0.381	0.0725	0.365	0.0549

3.5. Skin Signature for Male and Female Participants Having European and Asian Ethnicities

The measurements presented in this section of the paper are from 48 participants from two different ethnicities; European and Asian from both genders (24 male (12 European and 12 Asian), and 24 female (12 European and 12 Asian)). The measurements in Figures 14 and 15 represent the mean emissivity for male and female groups with error bars representing the systematic uncertainty.

Experimental measurements in Figure 14 indicate that the mean emissivity for the sample of Asian males is lower than that of European males at all measurement locations. The mean values of the differences in emissivity between Asian and European males were calculated to be ~ 0.04 for the inner wrist and the outer wrist locations, ~ 0.085 for palm of hand, back of hand and volar side locations, and ~ 0.11 for the dorsal surface location. These differences are likely to arise due to Asian skin being thinner than that of European skin and hydration levels and the water contents of the Asian skin being higher than that of European skin [34–36]. This makes Asian skin more reflective compared to European skin and as a result the mean emissivity of Asian participants is lower than that of European participants at all measurement locations. The standard deviations in the emissivity measurements for Asian and European male participants are summarized in Table 4 as follows:

Table 4. Standard deviation for Asian and European male participants at six measurement locations.

Location	SD for Asian Males	SD for European Males
Palm of Hand	± 0.081	± 0.080
Back of Hand	± 0.089	± 0.073
Inner Wrist	± 0.047	± 0.074
Outer Wrist	± 0.054	± 0.064
Volar Side of Forearm	± 0.041	± 0.081
Dorsal Surface of Forearm	± 0.051	± 0.068

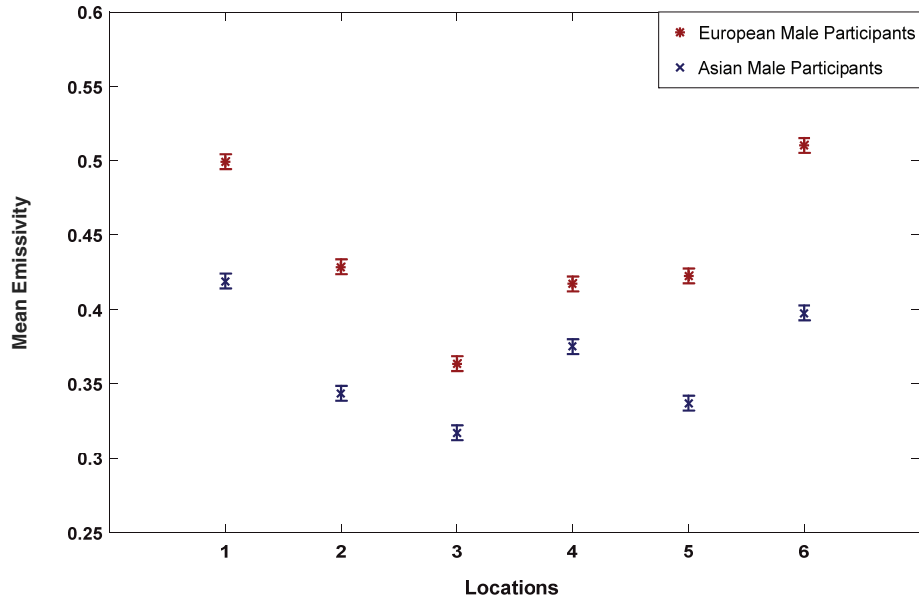

Figure 14. Mean emissivity of 24 male participants having Asian and European ethnicities at six locations: 1) palm of hand, 2) back of hand, 3) inner wrist, 4) outer wrist, 5) volar side, and 6) dorsal surface of the forearm.

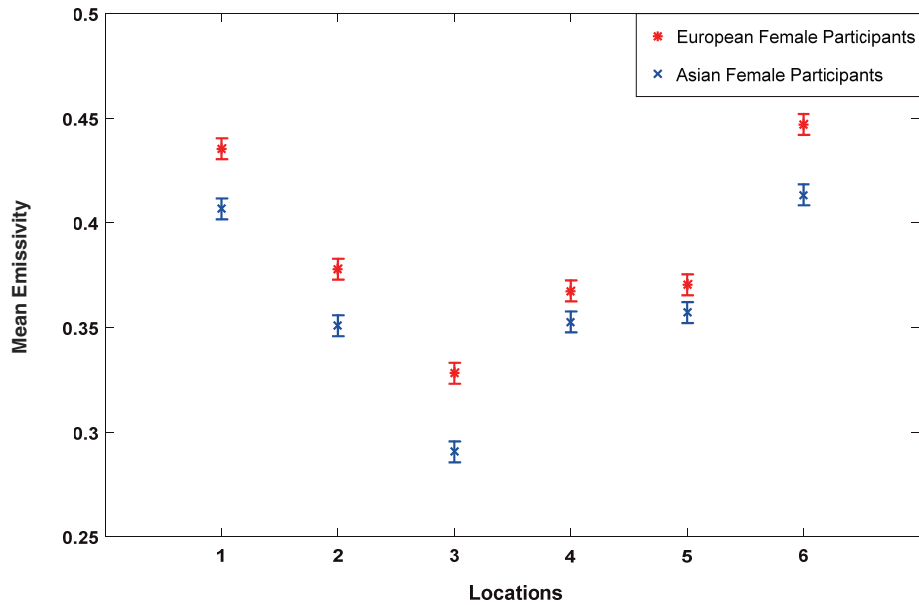

Figure 15. Mean emissivity of 24 female participants having Asian and European ethnicities at six measurements locations identified in Figure 14.

The measurements in Figure 15 indicate that there are differences in the mean emissivity values of skin between the Asian and European female samples, the measurements showing a similar trend to that of the males. However, the mean differences in the emissivity values between the two female groups were calculated to be in the range of 0.014 to 0.038 for all measurements locations. These differences are lower than that of the male groups. The standard deviation for Asian and European female groups is calculated and summarized in Table 5.

Table 5. Standard deviation for Asian and European female participants at six locations.

Location	SD for Asian Females	SD for European Females
Palm of Hand	± 0.072	± 0.103
Back of Hand	± 0.065	± 0.097
Inner Wrist	± 0.054	± 0.065
Outer Wrist	± 0.045	± 0.048
Volar Side	± 0.053	± 0.054
Dorsal Surface	± 0.050	± 0.060

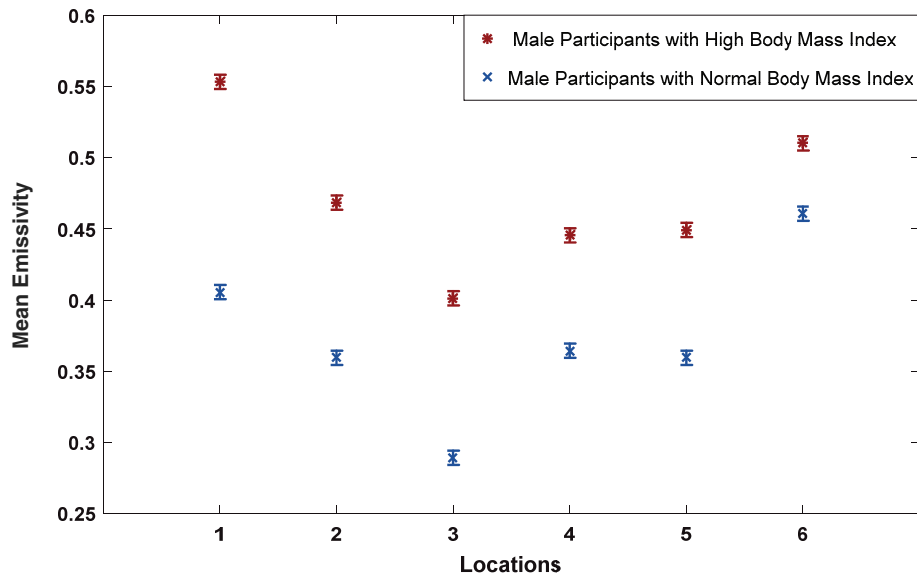

Figure 16. Mean emissivity for a sample of 10 male participants having normal and high body mass index on: 1) palm of hand, 2) back of hand, 3) inner wrist, 4) outer wrist, 5) volar side, and 6) dorsal surface of the forearm.

3.6. Skin Signature for Male and Female Having Normal and High Body Mass Index

Human skin becomes thicker with increasing body mass index (BMI) for both genders at any age [39], so variability in the emissivity of the skin from suitably selected participants was investigated. The measurements were performed on 20 participants (10 males and 10 females) having normal and high body mass index. For the purpose of this study, participants with BMI ranging between (18.5–24.9) kg/m² were classified as having normal BMI, whereas participants with BMI ranging between (25.0–29.9) kg/m² were classified as having high BMI [40]. Experimental measurements of the mean emissivity values of males with high and normal BMI are shown in Figure 16, with similar plots for females shown in Figure 17, with the corresponding values of the standard deviations shown in Tables 6 and 7.

Experimental measurements of the skin emissivity of males indicate that those with high BMI have on average an emissivity ~ 0.0981 higher than those with normal BMI, with the differences in the mean emissivity values across the different locations varying from ~ 0.05 to ~ 0.15 . These differences are consistent with the fact that human skin is getting thicker with increasing the BMI [39], a consequence of this being that blood vessels are further from the surface of the skin.

Experimental measurements of skin emissivity of females indicate that those with high BMI have on average an emissivity ~ 0.095 higher than those with normal BMI, with the differences in the mean emissivity values across the different arm locations varying from ~ 0.06 to ~ 0.14 , a result similar to the

Table 6. Standard deviation for 10 male participants having normal and high body mass index.

Location	Standard Deviation for Males with Normal BMI	Standard Deviation for Males with High BMI
Palm of Hand	± 0.039	± 0.049
Back of Hand	± 0.043	± 0.069
Inner Wrist	± 0.028	± 0.046
Outer Wrist	± 0.0136	± 0.064
Volar Side of Forearm	± 0.0567	± 0.077
Dorsal Surface of Forearm	± 0.078	± 0.067

Table 7. Standard deviation for 10 female participants having normal and high body mass index.

Location	Standard Deviation for Female with Normal (BMI)	Standard Deviation for Female with High (BMI)
Palm of Hand	± 0.015	± 0.054
Back of Hand	± 0.025	± 0.052
Inner Wrist	± 0.005	± 0.008
Outer Wrist	± 0.02	± 0.021
Volar Side of Forearm	± 0.005	± 0.027
Dorsal Surface of Forearm	± 0.045	± 0.042

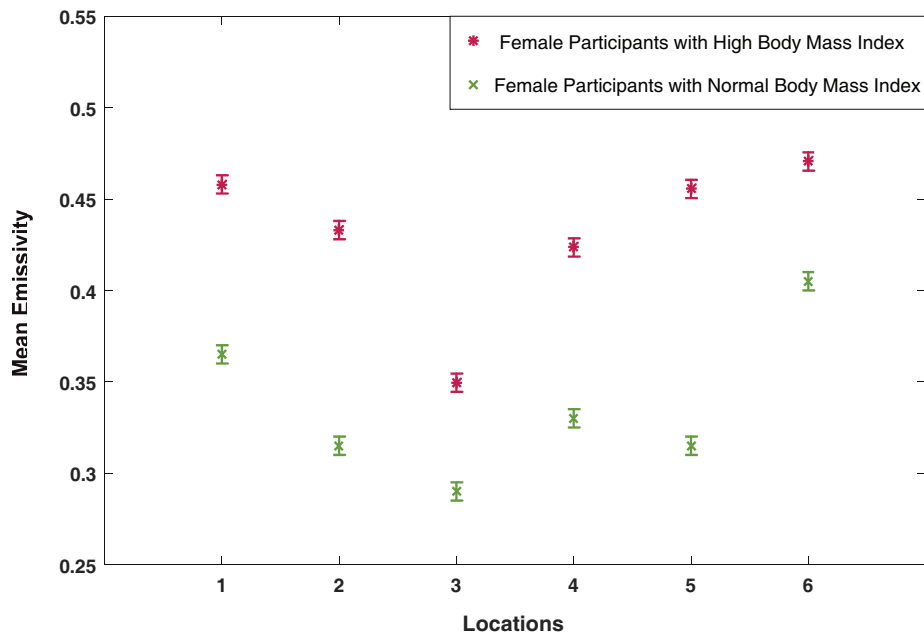

Figure 17. Mean emissivity for a sample of 10 female participants having normal and high body mass index at six measurement locations identified in Figure 16.

male group. However, the measurements of male emissivity indicate a larger scatter, this being 0.29 and 0.553 for those of normal and high BMI respectively. The corresponding scatter in the female group is 0.29 and 0.47 for normal and high BMI individuals. As with previous measurements these also indicate that the mean emissivity of males is ~ 0.038 higher than those of females.

4. IMPLICATIONS FOR SECURITY SCREENING

The implications of having model emissivities for different regions of the human body and different genders, ethnicities, body mass index and age groups, is that security screening of persons can become more of an automated process. As radiometry is used in the estimation of emissivity, any attempts at deception, by substituting a human skin surrogate over the body will be recognised as it will not fit the expected characteristics. This is because the emissivity is derived from the amount of radiation emitted by the body, not just from its reflection properties. This means that skin surrogates will be recognised even if they have exactly the same electrical properties as human skin. An active (coherent wave) illumination system will not have this capability, as it measures reflectivity directly. In a walk-through portal screening system a machine would process in a matter of second the radiometric measured emissivity from all regions of the human body together with a profile of the individual derived from gender, age and ethnicity. In a stand-off, crowd-surveillance or check-point screening scenario a similar process would take place, using emission data available from perhaps only one side of a subject.

5. DISCUSSION

Human skin signature for a sample of 60 participants over the frequency band 80–100 GHz indicates that there is a scatter in emissivity measurements over a range 0.17 to 0.68, and this is much greater than the experimental measurement uncertainty of ± 0.005 . The measurements show that the levels of thermal emission (emissivity and reflectance) vary consistently over different regions of the hand and forearm, with age, gender, body mass index and ethnicity. In general, the lower values of the mean emissivity are a result of measuring particularly thin skin on the inner wrist, volar side and back of hand, whereas higher values of mean emissivity are results of measuring thick skin on the outer wrist, dorsal surface and palm of hand. The measurements also show variation in emissivity from person to person, and at different locations on the human body. Estimating the sample mean emissivity values for the 36 males and 24 females separately for all measurement locations indicates that the difference between male and female emissivity is ~ 0.02 . This finding is consistent with the skin of males being thicker than that of females [31–33].

Experimental measurements of the differences in the emissivity between dry and wet skins on the palm of hand and back of hand regions indicate that radiometric sensitivity over the frequency band 80–100 GHz is sufficient to sense surfaces attached to the human skin. The measurements show a clear signature between normal skin and skin with water and this signature varies from person to person and between regions on the human body. The differences between wet and normal palm of hand skin are more significant than that of back of hand skin, and this is due to the thick (SC) layer that can retain water and make the hydration level for the palm of hand skin significantly higher in a wet state compared with a normal state. These results confirm that radiometry can identify surfaces attached to the human skin in tens of seconds and in the absence of any contact with or pat-down search of non-contact with the human body.

Experimental measurements of the mean emissivity of a sample of 24 male participants having Asian and European ethnicities show that the mean emissivity of male participants having Asian ethnicity is lower than that of male participants having European ethnicity over all measurement locations. The mean differences in emissivity values between Asian and European male participants were calculated to be in the range of 0.04 to 0.11. These differences are likely to be due to higher hydration level and thinner skin of Asian male participants [34–36].

Experimental measurements of the mean emissivity of a sample of 24 female participants having Asian and European ethnicities show that the mean emissivity of female participants having Asian ethnicity is lower than that of female participants having European ethnicity over all measurement locations. The mean differences in emissivity values between Asian and European female participants were calculated to be in the range of 0.014 to 0.038. Again, it is likely that these differences are due to thinner skin and higher hydration levels of female participants having Asian ethnicity compared with Europeans [34–36].

Experimental measurements of the mean emissivity of male and female groups having normal and high body mass index show that male and female groups with high BMI have higher mean emissivity

at all measurement locations compared with those having normal BMI. The mean differences in the emissivity values between the two male groups are calculated to be in the range of 0.05 to 0.15 for all measurement locations, these differences are also similar between the two females group. These results confirm that there are strong correlations between the skin thickness, the body mass index and the emissivity of the skin over the millimeter-wave frequency band (80–100) GHz for both genders.

It is recommended that further measurements are made on larger and more varied groups of individuals and overall body regions to provide statistics about the emissive and reflective properties of the human skin. This might be done on the skin directly and also on regions covered with clothing at ranges of frequencies over the millimeter wave frequency bands, the lower frequencies offering greater penetration into layers of clothing and down to the skin. The higher frequencies offer higher resolution. This will lead to greater understanding of human skin signature at the MMW frequency bands. When this is done, expected emissivity values can be identified at each location on the human body and these values can be compared with the measured emissivity from a template ensemble of recognised responses on an automated basis at security screening portals. Any deviation from the norm might identify anomalies. This will increase the detection probabilities, reduce the false alarm rate, and ensure high throughputs at entrances to future airport departure lounges and transport networks. An overview of the statistical analysis for the differences in the mean emissivity values between different locations and groups are summarized in Table 8:

Table 8. Overview of the statistical analysis for the human skin measured emissivity values.

Locations or Group	Differences in Emissivity \pm SD Males Participants	Differences in Emissivity \pm SD Females Participants
Palm and Back of Hand	0.0658 \pm 0.0531	0.0589 \pm 0.0375
Inner Wrist and Outer Wrist	0.0529 \pm 0.0345	0.0646 \pm 0.0394
Dorsal Surface and Volar Side	0.0675 \pm 0.0319	0.0729 \pm 0.0449
Dry and Wet Palm of Hand	0.148 \pm 0.074	0.135 \pm 0.054
Dry and Wet Back of Hand	0.056 \pm 0.045	0.0833 \pm 0.039
Normal and High BMI	Differences Range: 0.05–0.15 SD for Normal BMI: \pm 0.0704 SD for High BMI: \pm 0.0797 For All Six Locations	Differences Range: 0.06 to 0.14 SD for Normal BMI: \pm 0.0446 SD for High BMI: \pm 0.0549 For All Six Locations
Asian and European Participants	Differences: 0.04–0.11 SD for Asian: \pm 0.0726 SD for European: \pm 0.098 For All Locations	Differences: 0.014–0.038 SD for Asian: \pm 0.0723 SD for European: \pm 0.0875 For All Locations

6. CONCLUSIONS

A radiometer effective over the frequency band 80–100 GHz has been investigated and characterized for measuring the human skin signature of a sample of 60 healthy participants. The system was calibrated absolutely using liquid Nitrogen and ambient temperature sources. These measurements were used to characterize self-emission and millimeter wave radiation from a metal plate and fluorescent lights. The mean level of the self-emission reflected back from a metal plate was typically \pm 1.0 K above the background. Millimeter-wave emission emitted from a fluorescent light was found to increase the radiation temperature of the radiometer in the range of 62–74 K with a standard deviation of \pm 4.0 K.

Radiometric measurements made on a sample of 60 participants show that the mean emissivity of human skin varies from 0.17 to 0.68 over the 80 GHz to 100 GHz band. These variations are due to the differing water content and skin thicknesses of the participants. Statistical analysis on the data indicates that the mean emissivity of males over all measurements locations is higher than that of females by \sim 0.02. This supports the knowledge that on average the skin of males is thicker than that of females [31–33].

Experimental measurements of a sample of 36 male participants indicate that the mean differences in the emissivity values between the palm of hand and back of hand, the dorsal and volar regions of the forearm, and the inner and the outer wrist locations are: 0.0658, 0.0675 and 0.0529 with a sample standard deviation of 0.0531, 0.0319 and 0.0345 respectively. For female participants, the sample mean of the differences in the emissivity values between thinner and thicker skin regions were found to be: 0.0589, 0.0729 and 0.0646 respectively with a standard deviation of 0.0375, 0.0449, and 0.0394. These measurements indicate differences in the mean emissivity between the thinner and the thicker skin regions.

Experimental measurements of a sample of 16 participants (10 males and 6 females) indicate that the mean differences in the emissivity values between the normal and the wet palm of hand, and the normal and the wet back of hand skin are 0.143, and 0.066 with a sample standard deviation of 0.07, and 0.046, respectively. This indicates strong correlation between the human skin emissivity and the hydration level of the skin.

Experimental measurements of a sample of 48 male and female participants having Asian and European ethnicities indicate that the mean emissivity of the Asian sample of participant is lower than that of European sample of participants at all measurement locations, and this is due to the thinner skin and higher hydration levels of the skin of Asians.

Experimental measurements of a sample of 20 healthy participants from both genders having normal and high body mass index show that the group of participants with high BMI have higher mean emissivity values at all measurement locations than those having normal BMI. These measurements confirm a strong correlation between the human skin emissivity and the BMI, the latter being directly proportional to the skin thickness.

Research continues in this area to understand the signature of the human skin in the millimeter wave frequency bands and to design a full-body imaging security portal with machine anomaly detection for rapid walk-through, high-probability of detection, low false alarm rate screening.

REFERENCES

1. Zheng, C., X. Yao, A. Hu, and J. Miao, "A passive millimeter-wave imager used for concealed weapon detection," *Progress In Electromagnetics Research B*, Vol. 46, 379–397, 2013.
2. Yang, B.-H., Z.-P. Li, C. Zheng, J. Zhang, X.-X. Yao, A.-Y. Hu, and J.-G. Miao, "Design of a passive millimeter-wave imager used for concealed weapon detection BHU-2D-U," *WSEAS Transactions on Circuits and Systems*, Vol. 13, 94–103, 2014.
3. Appleby, R., "Passive millimetre-wave imaging and how it differs from terahertz imaging," *Philos. Trans. A Math. Phys. Eng. Sci.*, Vol. 362, 379–392, 2004, doi:10.1098/rsta.2003.1323
4. Harmer, S. W., N. Bowring, D. Andrews, N. D. Rezgui, M. Southgate, and S. Smith, "A review of nonimaging stand-off concealed threat detection with millimeter-wave radar," *IEEE Microwave Magazine*, Vol. 13, 160–167, 2012, doi:10.1109/MMM.2011.2174125.
5. Sheen, D. M., D. L. McMakin, and T. E. Hall, "Cylindrical millimeter-wave imaging technique for concealed weapon detection," *Proc. SPIE*, Vol. 3240, 0000, 1998, doi:10.1117/12.300061.
6. Salmon, N. A., "Experimental results and simulations from aperture synthesis three-dimensional radiometric imaging," *Proc. SPIE*, Vol. 9993, 99930B, 2016, doi:10.1117/12.2231696.
7. Salmon, N. A., "3-D radiometric aperture synthesis imaging," *IEEE Transactions on Microwave Theory and Technology*, Vol. 63, 3579–3587, 2015, doi:10.1109/TMTT.2015.2481413.
8. Rezgui, N.-D., D. A. Andrews, and N. J. Bowring, "Ultra wide band 3D microwave imaging scanner for the detection of concealed weapons," *Proc. SPIE*, Vol. 9651, 965108, 2015, doi:10.1117/12.2197581.
9. Blackhurst, E., N. Salmon, and M. Southgate, "Full polarimetric millimetre wave radar for stand-off security screening," *Proc. SPIE*, Vol. 10439, 1043906, 2017, doi:10.1117/12.2282564.
10. Ahmed, S. S., A. Schiessl, F. Gumbmann, M. Tiebout, S. Methfessel, and L.-P. Schmidt, "Advanced microwave imaging," *IEEE Microwave Magazine*, Vol. 13, 26–43, 2012, doi:10.1109/MMM.2012.2205772.

11. Ahmed, S. S., O. Ostwald, and L.-P. Schmidt, "Automatic detection of concealed dielectric objects for personnel imaging," *Proc. IEEE MTT-S International Microwave Workshop on Wireless Sensing, Local Positioning, and RFID*, 1–4, 2009, doi:10.1109/IMWS2.2009.5307899.
12. Luukanen, A., R. Appleby, M. Kemp, and N. Salmon, *Millimeter-Wave and Terahertz Imaging in Security Applications*, Vol. 171, Springer, Berlin, Heidelberg, 2012.
13. Salmon, N. A., "Extended sources near-field processing of experimental aperture synthesis data and application of the Gerchberg method for enhancing radiometric three-dimensional millimetre-wave images in security," *Proc. SPIE*, Vol. 10439, 1043905, 2017, doi:10.1117/12.2282563.
14. Salmon, N. A., J. R. Borrill, and D. G. Glee, "Absolute temperature stability of passive imaging radiometers," *Proc. SPIE*, Vol. 3064, 110–120, 1997, doi:10.1117/12.277072.
15. Pozar, D. M., *Microwave Engineering*, 4th edition, John Wiley & Sons, Hoboken, New Jersey, 2011.
16. Bardati, F. and D. Solimini, "Radiometric sensing of biological layered media," *Radio Science*, Vol. 18, 1393–140, 1983, doi:10.1029/RS018i006p01393.
17. Owda, A. Y., N. A. Salmon, N.-D. Rezgui, and S. Shylo, "Millimetre wave radiometers for medical diagnostics of human skin," *Proc. IEEE Sensors*, 1–3, 2017.
18. Harmer, S. W., S. Shylo, M. Shah, N. J. Bowring, and A. Y. Owda, "On the feasibility of assessing burn wound healing without removal of dressings using radiometric millimetre-wave sensing," *Progress In Electromagnetics Research M*, Vol. 45, 173–183, 2016.
19. Owda, A. Y., N. Salmon, S. W. Harmer, S. Shylo, N. J. Bowring, N. D. Rezgui, and M. Shah, "Millimeter-wave emissivity as a metric for the non-contact diagnosis of human skin conditions," *Bioelectromagnetics*, Vol. 38, 559–569, 2017, doi:10.1002/bem.22074.
20. Feldman, Y., A. Puzenko, P. Ben Ishai, A. Caduff, and A. J. Agranat, "Human skin as arrays of helical antennas in the millimeter and submillimeter wave range," *Physical Review Letters*, Vol. 100, 128102, 2008, doi:https://doi.org/10.1103/PhysRevLett.100.128102.
21. Feldman, Y., A. Puzenko, P. Ben Ishai, A. Caduff, I. Davidovich, F. Sakran, and A. J. Agranat, "The electromagnetic response of human skin in the millimetre and submillimetre wave range," *Physics in Medicine & Biology*, Vol. 54, 3341–3363, 2009, doi:https://doi.org/10.1088/0031-9155/54/11/005.
22. Smulders, P. M. F., "Analysis of human skin tissue by millimeter-wave reflectometry," *Skin Research and Technology*, Vol. 19, e209–e216, 2012, doi:10.1111/j.1600-0846.2012.00629.x.
23. Owda, A. Y., N.-D. Rezgui, and N. A. Salmon, "Signatures of human skin in the millimetre wave band (80–100) GHz," *Proc. SPIE*, Vol. 10439, 1043904, 2017, doi:10.1117/12.2292046.
24. K uchler, N., D. D. Turner, U. L ohnert, and S. Crewell, "Calibrating ground-based microwave radiometers: Uncertainty and drifts," *Radio Science*, Vol. 51, 311–327, 2016, doi:10.1002/2015RS005826.
25. Salmon, N. A., L. Kirkham, and P. N. Wilkinson, "Characterisation and calibration of a large aperture (1.6 m) ka-band indoor passive millimeter wave security screening imager," *Proc. SPIE*, Vol. 8544, 854408, 2012, doi:10.1117/12.999278.
26. Lee, Y. and K. Hwang, "Skin thickness of Korean adults," *Surgical and Radiologic Anatomy*, Vol. 24, 183–189, 2002, doi:10.1007/s00276-002-0034-5.
27. Gray, H., *Anatomy of the Human Body*, Lea & Febiger, Philadelphia, Pennsylvania, 1981.
28. McGrath, J. A. and J. Uitto, *Rook's Textbook of Dermatology*, 9th edition, Wiley-Blackwell, Oxford, UK, 2016.
29. Zhadobov, M., N. Chahat, R. Sauleau, C. L. Quement, and Y. L. Drean, "Millimeter-wave interactions with the human body: State of knowledge and recent advances," *International Journal of Microwave and Wireless Technologies*, Vol. 3, 237–247, 2011, doi:https://doi.org/10.1017/S1759078711000122.
30. Alekseev, S. I., I. Szabo, and M. C. Ziskin, "Millimeter wave reflectivity used for measurement of skin hydration with different moisturizers," *Skin Research and Technology*, Vol. 14, 390–396, 2008, doi:10.1111/j.1600-0846.2008.00319.x.

31. Giacomoni, P. U., T. Mammone, and M. Teri, "Gender-linked differences in human skin," *Journal of Dermatological Science*, Vol. 55, 144–149, 2009, doi: <https://doi.org/10.1016/j.jdermsci.2009.06.001>.
32. Sandby-Møller, J., T. Poulsen, and H. C. Wulf, "Epidermal thickness at different body sites: relationship to age, gender, pigmentation, blood content, skin type and smoking habits," *Acta Derm Venereol*, Vol. 83, 410–413, 2003, doi:10.1080/00015550310015419.
33. Shuster, S., M. M. Black, and E. Mcvitie, "The influence of age and sex on skin thickness, skin collagen and density," *Br. J. Dermatol.*, Vol. 93, 639–643, 1975, doi:10.1111/j.1365-2133.1975.tb05113.x.
34. Rawlings, A. V., "Ethnic skin types: Are there differences in skin structure and function?," *International Journal of Cosmetic Science*, Vol. 28, 79–93, 2006, doi:10.1111/j.1467-2494.2006.00302.x.
35. Sugino, K., G. Imokawa, and H. I. Maibach, "Ethnic difference of varied stratum corneum function in relation to stratum corneum lipids," *Journal of Dermatological Science*, Vol. 6, 108, 1993, doi: [https://doi.org/10.1016/0923-1811\(93\)91343-S](https://doi.org/10.1016/0923-1811(93)91343-S).
36. Hillebrand, G. G., M. J. Levine, and K. Shigaki-Miyamoto, "The age dependent changes in skin condition in African Americans, Asian Indians, Caucasians, East Asians & Latinos," *IFSCC Magazine*, Vol. 4, 259–266, 2001.
37. Williams, G. F., "Microwave emissivity measurements of bubbles and foam," *IEEE Trans. Geosci. Elect.*, Vol. 9, 221–224, 1971, doi: 10.1109/TGE.1971.271504.
38. Rose, L. A., W. E. Asher, S. C. Reising, P. W. Gaiser, K. M. St Germain, D. J. Dowgiallo, K. A. Horgan, G. Farquharson, and E. J. Knapp., "Radiometric measurements of the microwave emissivity of foam," *IEEE Trans. Geosci. Remote Sens*, Vol. 40, 2619–2625, 2002, doi: 10.1109/TGRS.2002.807006.
39. Derraik, J. G. B., M. Rademaker, W. S. Cutfield, T. E. Pinto, S. Tregurtha, A. Faherty, J. M. Peart, P.L. Drury, and P. L. Hofman, "Effects of age, gender, BMI, and anatomical site on skin thickness in children and adults with diabetes," *PLoS ONE*, Vol. 9, e86637, 2014, doi: <https://doi.org/10.1371/journal.pone.0086637>.
40. Jackson, A. S., P. R. Stanforth, J. Gagnon, T. Rankinen, A. S. Leon, D. C. Rao, J. S. Skinner, C. Bouchard, and J. H. Wilmore, "The effect of sex, age and race on estimating percentage body fat from body mass index: The Heritage Family Study," *International Journal of Obesity*, Vol. 26, 789–796, 2002, doi:10.1038/sj.ijo.0802006.
41. Alekseev, S. I. and M. C. Ziskin, "Human skin permittivity determined by millimeter wave reflection measurements," *Bioelectromagnetics*, Vol. 28, 331–339, 2007, doi: 10.1002/bem.20308.
42. Egot-Lemaire, S. J.-P. and M. C. Ziskin, "Dielectric properties of human skin at an acupuncture point in the 50–75 GHz frequency range. A pilot study," *Bioelectromagnetics*, Vol. 32, 360–366, 2011, doi: 10.1002/bem.20650.
43. Gabriel. S., R. W. Lau, and C. Gabriel, "The dielectric properties of biological tissues: III. Parametric models for the dielectric spectrum of tissues," *Physics in Medicine and Biology*, Vol. 41, 2271–2293, 1996.
44. Gabriel. S., R. W. Lau, and C. Gabriel, "The dielectric properties of biological tissues: II. Measurements in the frequency range 10Hz to 20 GHz," *Physics in Medicine and Biology*, Vol. 41, 2251–2269, 1996.
45. Wallace V. P., J. Fitzgerald, S. Shankar, N. Flanagan, R. Pye, J. Cluff, and D. D. Arnone, "Terahertz pulsed imaging of basal cell carcinoma ex vivo and in vivo," *British Journal Dermatology*, Vol. 151, 424–432, 2004, doi:10.1111/j.1365-2133.2004.06129.x.