

STUDY ON AN S-BAND RECTENNA ARRAY FOR WIRELESS MICROWAVE POWER TRANSMISSION

Wen Huang, Biao Zhang, Xing Chen, Kama Huang, and Changjun Liu*

School of Electronics and Information Engineering, Sichuan University, Chengdu 610064, China

Abstract—The microwave power transmission is an approach for wireless power transmission. As an important component of a microwave wireless power transmission systems, microwave rectennas are widely studied. A rectenna based on a microstrip dipole antenna and a microwave rectifier with high conversion efficiency were designed at 2.45 GHz. The dipole antenna achieved a gain of 5.2 dBi, a return loss greater than 10 dB, and a bandwidth of 20%. The microwave to DC (MW-DC) conversion efficiency of the rectifier was measured as 83% with 20 dBm input power and 600 Ω load. There are 72 rectennas to form an array with an area of 50 cm by 50 cm. The measured results show that the arrangement of the rectenna connection is an effective way to improve the total conversion efficiency, when the microwave power distribution is not uniform on rectenna array. The experimental results show that the highest microwave power transmission efficiency reaches 67.6%.

1. INTRODUCTION

Microwave power transmission (MPT) [1] system is to wirelessly transmit microwave power from one location to another, in which the transmitted microwave power is received and converted to DC power. In the system, a rectenna is a key component which determines the power capability and MW-DC conversion efficiency of the entire system. It generally consists of an antenna which receives microwave power and a rectifier which converts the microwave power to DC power. Actually a single rectenna cannot satisfy MPT system due to its low power capacitance. Therefore, a rectenna array is a must in application systems.

Received 3 December 2012, Accepted 8 January 2013, Scheduled 11 January 2013

* Corresponding author: Changjun Liu (cjliu@ieee.org).

Recently many kinds of rectenna were reported, including linear and circular polarization with plenty of different configures. A lot of researches are interested in a single rectenna or a low power rectenna array at a fixed transmission distance [2–11]. In an MPT system, a rectenna array at a level of several watts is convenient and useful [9]. At the same time, the transmission distance is an essential factor as well, which influences the system efficiency and output DC power.

In this paper, we have designed and fabricated a rectenna array with 8 by 9 rectenna units at S-band. Each rectenna element consists of a microstrip dipole antenna and a high efficiency microstrip rectifier, which are bonded together with connectors. Microstrip dipole-antennas and rectifiers are light, compact, and easy to fabricate. They are suitable to compose an rectenna array. In the following sections, we describe the S-band rectenna design and array arrangement in details.

2. RECTENNA ARRAY

The rectennas at ISM (Industry, Science, and Medicine) band, e.g., 2.45 GHz, are developed in microwave power transmission systems. Compared with the diodes at 5.8 GHz [6, 11] or other higher frequencies [2], the diodes at 2.45 GHz [12] provide higher breakdown voltage and power capacitance. A 2.45 GHz rectenna array presents better DC voltage and power handling for practical applications.

2.1. Microstrip Dipole Antenna

The realized microstrip dipole antenna [13, 14] is shown in Figure 1. The antenna is printed on a 1 mm thick FR-4 ($\epsilon_r = 4.4$) substrate. On the front side, the length of the dipole radiator shown in Figure 1(a) is $\lambda/4$. Figure 1(b) shows an open-ended compensation stub and a printed balun which fed by a microstrip line [15, 16]. At the bottom of the antenna, a reflection plate is added to enhance the radiation

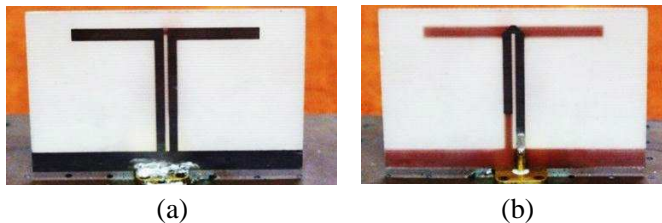

Figure 1. (a) Front side and (b) reverse side of microstrip dipole antenna.

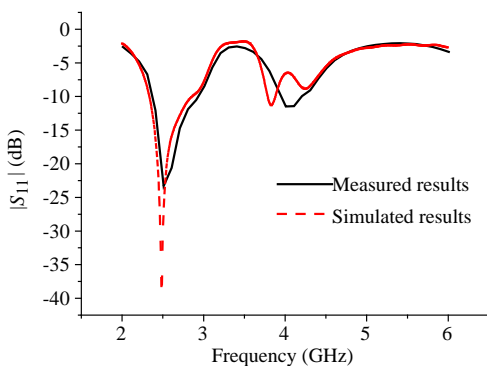

Figure 2. Simulated and measured results for $|S_{11}|$.

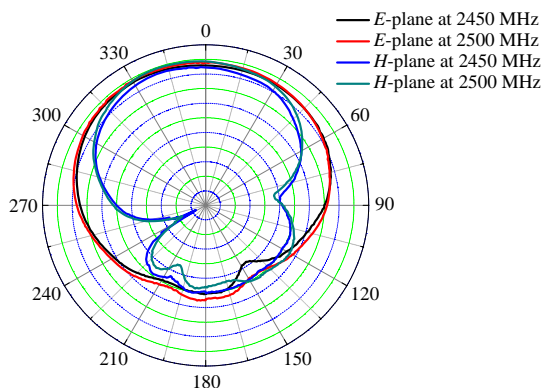

Figure 3. Measured radiation pattern of the dipole antenna.

directivity and gain. Furthermore, the plate plays the role of matching the output impedance of the dipole antenna to $50\ \Omega$. Thus, each antenna can be connected to a SMA connector.

Figure 2 presents the simulated and measured $|S_{11}|$ parameters of the dipole antenna. The measured bandwidth is about 25% which covers the design frequency from 2.34 GHz to 2.86 GHz. Figure 3 shows the measured radiation pattern of the microstrip dipole antenna at 2.45 GHz and 2.5 GHz. The 3 dB beamwidth is 132° for E plane and 81° for H plane at 2.45 GHz. At the same instant, the 3 dB beamwidth is 125° for E plane and 79° for H plane at 2.5 GHz. In MPT system, the incident angles at the surface of rectenna array are different from the edge to the center. A wide 3 dB beamwidth antenna provides better reception than a narrow one when microwave is in different directions. The measured gain of the antenna is 5.2 dBi at 2.45 GHz.

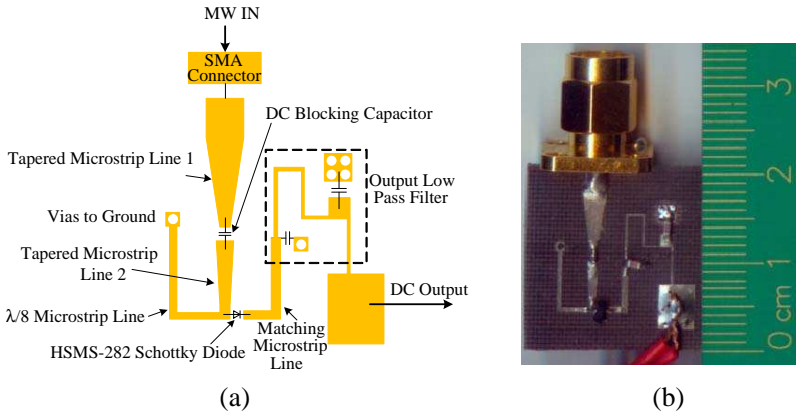

Figure 4. (a) Layout and (b) photo of proposed rectifier.

2.2. 2.45 GHz Microstrip Rectifier Design

The 2.45 GHz microwave rectifying circuit is constructed based on HSMS-282 Schottky diode and printed on a 1 mm thick F4B-2 ($\epsilon_r = 2.65$) substrate [12]. The rectifier consists of two tapered microstrip lines, a DC blocking capacitor, a Schottky diode, a $\lambda/8$ short-ended microstrip line, a matching microstrip line, and an output low pass filter.

The layout and photo of proposed rectifier are shown in Figures 4(a) and (b), respectively. The tapered microstrip line 1 is applied to matching the input impedance of the circuit to 50Ω . Then its impedance is matched to the dipole antenna. The tapered microstrip line 2 is used to matching impedance between the DC blocking capacitor and HSMS-282 Schottky diode. The impedance of the diode at f_0 is defined as

$$Z_d = \frac{\pi R_s}{\cos \theta_{on} \left(\frac{\theta_{on}}{\cos \theta_{on}} - \sin \theta_{on} \right) + j\omega R_s C_j \left(\frac{\pi - \theta_{on}}{\cos \theta_{on}} + \sin \theta_{on} \right)} \quad [11] \quad (1)$$

where C_j , R_s and θ_{on} are the junction capacitance, the series resistance, and the forward-bias turn-on angle, respectively. A $\lambda_g/8$ short-ended microstrip line is equivalent to an inductance at the fundamental frequency but a $\lambda_g/4$ resonator at the second harmonic. Therefore, this microstrip line cancels the imaginary part of diode impedance to enhance the rectifying efficiency at fundamental frequency. The inductive reactance is defined as

$$jX_L = j2\pi f_0 L = jZ_0 \tan(\beta l) \quad (2)$$

where Z_0 and β are the characteristic impedance and propagation constant, respectively. While $l = \lambda_g/8$, $L = \frac{Z_0}{2\pi f_0}$. At the second harmonic, the equivalent resonator rejects the harmonic wave to the diode during rectifying.

A low pass filter is applied before the DC output port to blocking the harmonic frequencies produced in rectifying. The harmonic waves are directly reflected back to the diode due to the diode connecting form is in series but not in parallels. Then, the harmonics are re-rectified by the diode.

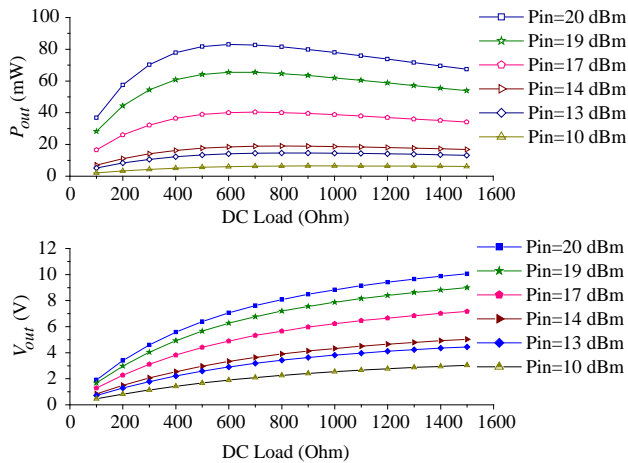

Figure 5. Measured DC voltage and power output with respect to the load at different input power.

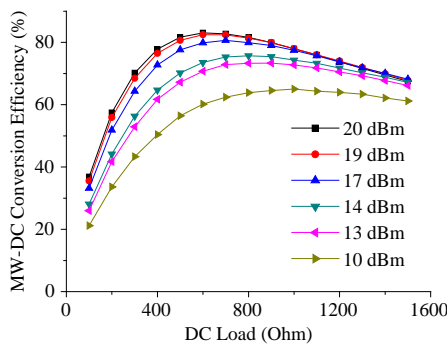

Figure 6. Measured MW-DC conversion efficiency with respect to the load at different input power.

ADS software is applied to simulating the schematic and layout of the rectifier, and analyzing the rectifying efficiency at given input microwave power while the load varies within a certain range. Figure 5 presents the measured DC voltage and output power with respect to the loads at different input power. The maximum voltage reaches 10.06 V. When the maximum DC power achieves 83.1 mW at 20 dBm microwave input, the experimental DC output voltage attains 7.06 V at a 600 Ohm load. Figure 6 shows the measured conversion efficiency with respect to different input powers. The highest efficiency of 83.1% is achieved at an input power of 20 dBm and DC load with 600 Ohm. The measured rectifying efficiency is higher than 60% when the input microwave power is between 10 dBm to 20 dBm. When the input MW power increases, the optimal DC load decreases to achieve the best MW-DC conversion efficiency.

In most cases, the microwave power distribution on a rectenna array is not uniform and decreases from center to edge. High rectifying efficiency at low input power ensures the rectennas at edge of an array work as well as center.

2.3. Rectenna Array

Figure 7 shows the realized rectenna array (50 cm by 50 cm). In each rectenna element, the antenna and rectifying circuit are fitted together by a SMA connector through the reflection plate. The 72 elements are arranged as rows of $\lambda/2$ equilateral triangle shown in Figure 8. Each element is placed on the vertex of the triangles [10]. The triangular arrangement ensures that the overlap of the aperture between adjacent receiving antennas is minimum and the entire array is uniformly covered by aperture of receiving antennas [17–22].

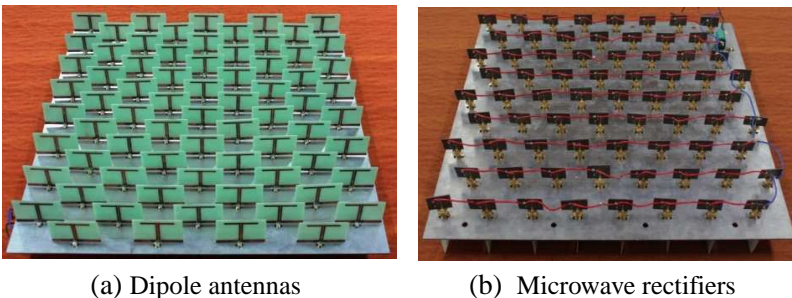

Figure 7. (a) Front side and (b) reverse side of rectenna array.

3. MICROWAVE POWER TRANSMISSION EXPERIMENTS

Figure 9 shows the rectenna measurement configures. The rectenna array was experimented at close and short distances respectively on this configure.

3.1. Close Distance Experiment

In close distance transmission experiment, the range between transmitting antenna and rectenna array is λ , i.e., 12.2 cm, where the power reflected to transmitting antenna equals to zero. The transmitting antenna is a 16 dBi horn antenna. Therefore, the power distribution on the array is not uniform at this distance.

At first, the rectifiers are connected parallel as shown in Figure 10(a) while R_1 equals 10Ω . Afterward, changing the connection form presented in Figure 10(b), R_2 and R_3 equal 15Ω and 25Ω ,

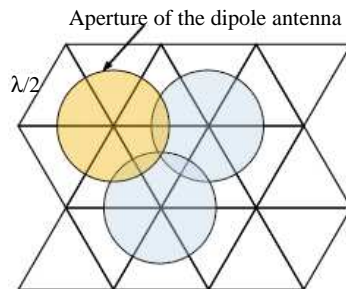

Figure 8. Schematic of the rectenna array arrangement.

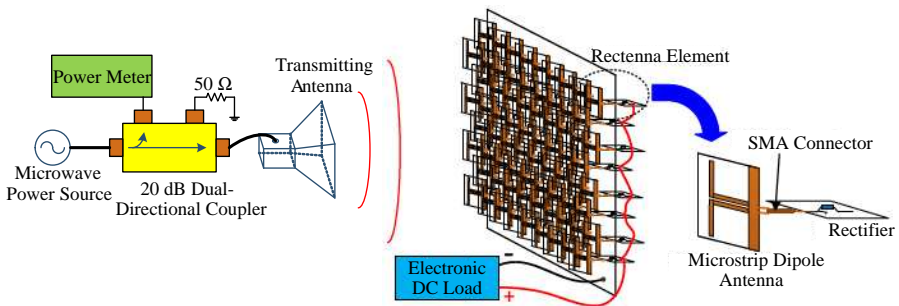

Figure 9. Rectenna measurement configure.

respectively. Figure 11 shows the measured total transmission efficiency of the rectenna array in different parallel connection forms. In form (b), the efficiency is nearly 5% improved compared with form (a). Carrying different loads is an effective way to improve total transmission efficiency when the power distribution is not uniform on the array in close distance microwave power transmission.

3.2. Short Distance Experiment

In short distance experiments, the transmission distance is greater than 29λ and the transmitting antenna is a 24 dBi parabolic grid antenna. The rectifiers are parallel connected as shown in Figure 10(a). The power densities at 3.5 m, 4 m and 4.5 m are 55.6 W/m^2 , 35.7 W/m^2 and

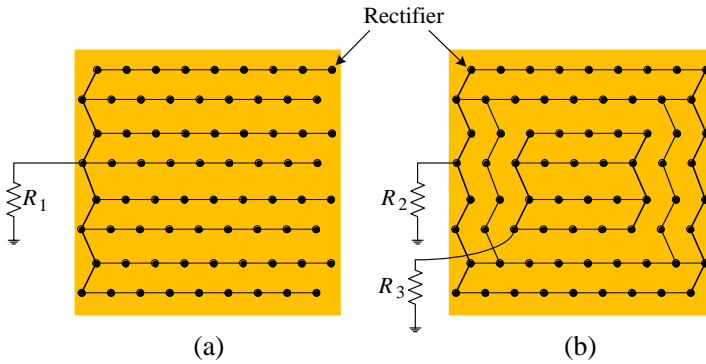

Figure 10. Different parallel connection forms of rectifiers at near transmission distance.

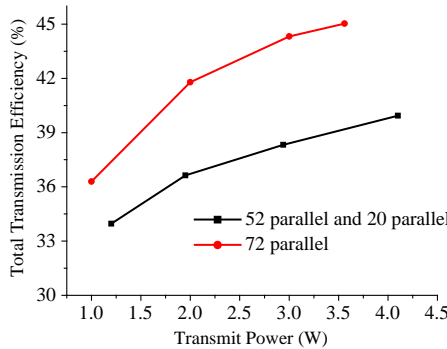

Figure 11. Total transmission efficiency in different forms of paralleled connection after measuring.

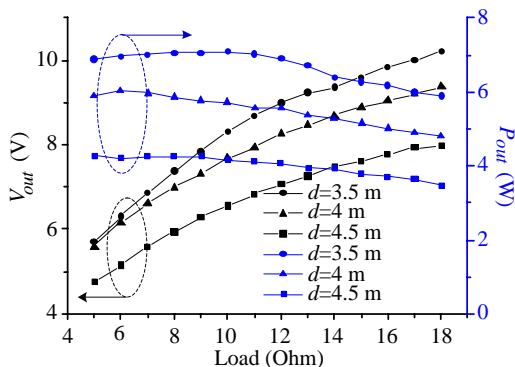

Figure 12. Measured DC voltage and power with respect to the load at different transmission distance.

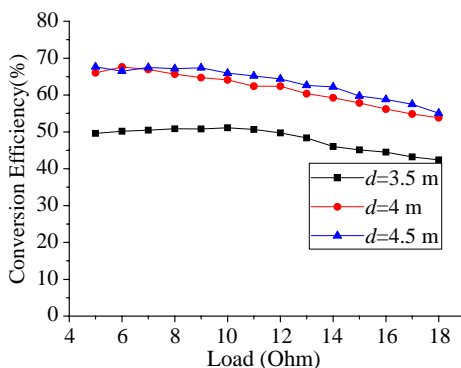

Figure 13. Measured conversion efficiency with respect to the load at different transmission distance.

25.3 W/m², respectively, which are measured by a 16 dBi horn receiving antenna. The conversion efficiency is defined as

$$\eta = \frac{P_{DC}}{s_d \times A_{Rectenna-array}} \times 100\% \tag{3}$$

where P_{DC} is the output DC power, s_d the power density at distance d , and $A_{Rectenna-array}$ the area of the rectenna array.

Figure 12 shows the measured DC output voltage and power with respect to the load at different transmission distance. The maximum voltage is 10.38 V which almost equals to the maximum voltage of single rectifier. The output power is basically steady when the load continually increases. The experimental DC output voltage achieves

8.5 V with a 10 Ohm load while the maximum DC output power attains 7.1 W at 3.5 m. Figure 13 shows the measured conversion efficiency with respect to the load at different transmission distance. When the maximum DC output power is 7.1 W, the efficiency reaches 51.1%. The highest efficiency is 67.6% at the distance of 4 m with 6 Ohm load. A majority of the lower efficiency is attributed to the ununiformed power density on the array at 3.5 m. However, the efficiency is better at 4 m and 4.5 m in general because that the power distribution is better.

4. CONCLUSION

A novel S-band rectenna array is proposed to increase the conversion efficiency and power capacitance. The three-dimensional structure of the rectenna array enhanced the compactness of the array, since the projected area of the dipole antenna in the reflecting surface is much less than the patch antenna area. The triangular arrangement similarly makes it possible to place more elements independently in a limited space. The more rectenna elements the system has, the greater the power capacitance is. The measured conversion efficiency of the rectifier is over 60% with 10 dB dynamic range of input power and highest efficiency reaches 83.1%. The connection of rectennas is an effective way to improve total transmission efficiency, when the power distribution is not uniform on the array. The maximum DC output power and highest conversion efficiency of rectenna array are 7.1 W and 67.6%, respectively. Moreover, artificial transmission lines may be applied to make the rectenna more compact [15]. This rectenna array may be applied to large scale of a microwave power transmission system in future.

ACKNOWLEDGMENT

This work was supported in part by the NFSC 60971051 and 61271074, the Key Laboratory of Cognitive Radio (GUET) MOE, China, and the 863 project 2012AA120605.

REFERENCES

1. Brown, W. C., "The history of power transmission by radio waves," *IEEE Transactions on Microwave and Techniques*, Vol. 32, No. 9, 1230–1242, Sep. 1984.
2. Yu, C., C. Liu, B. Zhang, X. Chen, and K. Huang, "An intermodulation recycling rectifier for microwave transmission at

- 2.45 GHz,” *Progress In Electromagnetics Research*, Vol. 119, 435–447, 2011.
3. Park, S. I., “Enhancement of wireless power transmission into biological tissues using a high surface impedance ground plane,” *Progress In Electromagnetics Research*, Vol. 135, 123–136, 2013.
 4. Zeljami, K., J. Gutierrez, J. P. Pascual, T. Fernandez, A. Tazon, and M. Boussouis, “Characterization and modeling of Schottky diodes up to 110 GHz for use in both flip-chip and wire-bonded assembled environments,” *Progress In Electromagnetics Research*, Vol. 131, 457–475, 2012.
 5. Feng, T., Y. Li, H. Jiang, W. Li, F. Yang, X. Dong, and H. Chen, “Tunable single-negative metamaterials based on microstrip transmission line with varactor diodes loading,” *Progress In Electromagnetics Research*, Vol. 120, 35–50, 2011.
 6. Strassner, B. and K. Chang, “5.8 GHz circularly polarized rectifying antenna for wireless microwave power transmission,” *IEEE Transactions on Microwave Theory and Techniques*, Vol. 50, No. 8, 1870–1876, Aug. 2002.
 7. Shinohara, N. and H. Matsumoto, “Experimental study of large rectenna array for microwave energy transmission,” *IEEE Transactions on Microwave Theory and Techniques*, Vol. 46, No. 3, 261–268, Mar. 1998.
 8. Zhang, B., X. Zhao, C. Yu, K. Huang, and C. Liu, “A power enhanced high efficiency 2.45 GHz rectifier based on diode array,” *Journal of Electromagnetic Waves and Applications*, Vol. 25, Nos. 5–6, 765–774, 2011.
 9. He, Q. and C. Liu, “An enhanced microwave rectifying circuit using HSMS-282,” *Microwave and Optical Technology Letters*, Vol. 51, No. 4, 1151–1153, Apr. 2009.
 10. Strassner, B. and K. Chang, “Highly efficient C-band circularly polarized rectifying antenna array for wireless microwave power transmission,” *IEEE Transactions on Antennas and Propagation*, Vol. 51, No. 6, 1347–1356, Jun. 2003.
 11. McSpadden, J. O., L. Fan, and K. Chang, “Design and experiments of a high-conversion-efficiency 5.8-GHz rectenna,” *IEEE Transactions on Microwave Theory and Techniques*, Vol. 46, No. 12, 2053–2060, Dec. 1998.
 12. Zhang, B., C. Liu, and K. Huang, “Design and realization of a miniaturized high efficiency 2.45 GHz microwave rectifier,” *Proceeding of National Conference on Microwave and Millimeter Waves in China*, 1693–1696, 2011.

13. Tsai, C.-L., "A coplanar-strip dipole antenna for broadband circular polarization operation," *Progress In Electromagnetics Research*, Vol. 121, 141–157, 2011.
14. Kraus, J. D. and R. J. Marhefka, *Antennas: For All Applications*, 3rd Edition, 810–812, Chinese Publish House of Electronics Industry, 2008.
15. Huang, W., C. Liu, L. Yan, and K. Huang, "A miniaturized dual-band power divider with harmonic suppression for GSM applications," *Journal of Electromagnetic Waves and Applications*, Vol. 24, No. 1, 81–91, 2010.
16. Yeh, Z.-Y. and Y.-C. Chiang, "A miniature CPW balun constructed with length-reduced 3dB couplers and a short redundant transmission line," *Progress In Electromagnetics Research*, Vol. 117, 195–208, 2011.
17. Costa, F., S. Genovesi, and A. Monorchio, "A frequency selective absorbing ground plane for low-RCS microstrip antenna arrays," *Progress In Electromagnetics Research*, Vol. 126, 317–332, 2012.
18. Wang, C.-J. and Y. Dai, "Studies of power-combining of open slot antenna arrays," *Progress In Electromagnetics Research*, Vol. 120, 423–437, 2011.
19. Rodríguez-González, J. A. and F. J. Ares-Pena, "Design of planar arrays composed by an active dipole above a ground plane with parasitic elements," *Progress In Electromagnetics Research*, Vol. 119, 265–277, 2011.
20. Alvarez Folgueiras, M., J. A. Rodríguez-González, and F. J. Ares-Pena, "Experimental results on a planar array of parasitic dipoles FED by one active," *Progress In Electromagnetics Research*, Vol. 113, 369–377, 2011.
21. Wang, W.-B., Q. Feng, and D. Liu, "Application of chaotic particle swarm optimization algorithm to pattern synthesis of antenna arrays," *Progress In Electromagnetics Research*, Vol. 115, 173–189, 2011.
22. Li, R., L. Xu, X.-W. Shi, N. Zhang, and Z.-Q. Lv, "Improved differential evolution strategy for antenna array pattern synthesis problems," *Progress In Electromagnetics Research*, Vol. 113, 429–441, 2011.