

# A Novel Dual Band-Notched CPW-Fed UWB MIMO Antenna with Mutual Coupling Reduction Characteristics

Jingjing Zhang\*, Lingye Wang, and Wen Zhang

**Abstract**—A novel dual band-notched CPW-fed UWB MIMO antenna with mutual coupling reduction characteristics is presented in this paper. The proposed antenna uses CPW feeding to expand the antenna bandwidth. The measured impedance bandwidth with  $S_{11} < -10$  dB is 137% from 3 GHz to 16 GHz. The overall size of the antenna is 46 mm  $\times$  32 mm  $\times$  1.6 mm. In order to achieve dual band-notched characteristics, a cup-shaped branch is added to the grounding plate, and a step impedance resonator (SIR) is added to the microstrip line. By adding periodic strip branches on the back of the antenna, the mutual coupling between the two antennas is significantly reduced, which meets the requirements of practical applications. In addition, the proposed antenna has a compact size and can provide a stable radiation pattern, which is suitable for UWB communication systems.

## 1. INTRODUCTION

With social advancement, people have put forward higher requirements for communication rate and communication efficiency. As we all know, a ultra-wideband (UWB) multiple-input and multiple-output (MIMO) wireless communication system combining UWB technology and MIMO technology can effectively increase the channel capacity of the system, reduce the channel error rate, increase the working bandwidth, and improve the channel capacity of the UWB communication system without additional bandwidth consumption, which has the advantages of low power consumption and high gain, so UWB MIMO antenna design in the field of wireless communications has received more and more attention [1–5], but in this frequency band, there also exist bands such as WLAN (5.15–5.825 GHz), satellite communication X-band downlink frequency band (7.25–7.75 GHz), and other narrower frequency bands. In order to avoid the above-mentioned frequency bands causing interference to UWB, and for the needs of antenna miniaturization and integration, the research of UWB MIMO antenna has become a hot topic in recent years [6–8].

[9] proposed a UWB MIMO antenna with a compact size of 18 mm  $\times$  34 mm. By etching an inverted L-shaped slit on the radiating element, the band-notched characteristics at the wireless local area network and IEEE INSAT/Super-Extended are realized. [10] proposed a novel compact UWB MIMO antenna with dual polarizations and band-notched characteristics. The band-notched characteristic of the WLAN frequency band is realized by etching the curved slit in each radiating element. [11] proposed and produced a UWB MIMO Vivaldi antenna with dual band-notched characteristics. By etching a T-shaped groove in the ground plane, the port isolation between individual antenna elements can be greatly increased. At the same time, by adding two open-loop resonators (SRR) of different sizes next to the microstrip feeder, it is possible to filter out interference from WLAN and X-band. [12] proposed a novel high-performance quaternary UWB MIMO antenna. The three band-notched characteristics are achieved by embedding different types of slots in the ground plate and decoupling structure, respectively.

---

*Received 27 December 2019, Accepted 8 February 2020, Scheduled 17 February 2020*

\* Corresponding author: Jingjing Zhang (jjz4113@163.com).

The authors are with the Shandong University of Science and Technology, College of Electronic Information Engineering, Qingdao, Shandong 266590, China.

[13] proposed a compact MIMO antenna with WLAN band-notch characteristics, which is suitable for portable wireless UWB systems. The antenna includes two identical planar monopole antenna elements, namely PM1 and PM2. In order to reduce mutual coupling and increase impedance bandwidth, a long rectangular strip is added between PM1 and PM2. To achieve band-notched characteristics of the WLAN band, an inverted U-shaped groove is etched on the feeder. Although the above-mentioned antenna has better performance, the band-notched structure is relatively simple and lacks innovation. This paper presents a novel dual band-notched Coplanar Waveguide (CPW)-fed UWB MIMO antenna with mutual coupling reduction characteristics. The antenna bandwidth ranges from 3 GHz to 16 GHz with a relative bandwidth of 137%. The dual band-notched characteristic is achieved by connecting cup-shaped branches above the ground plane and loading a step impedance resonator (SIR) structure in the CPW transmission line, and the corresponding center frequencies of these notch bands can be controlled by adjusting the size of the cup-shaped branch and SIR structure. By adding periodic strip branches on the back of the antenna, the mutual coupling between the two antennas is significantly reduced, which meets the requirements of practical applications.

## 2. ANTENNA DESIGN

The UWB MIMO antenna designed in this paper is shown in Figure 1. The dielectric substrate is an FR4 substrate with a dielectric constant of 4.4 and thickness of 1.6 mm. The design process of the antenna band-notched structure is shown in Figure 2. By checking the current distribution of the UWB antenna, the positions of the WLAN band and X band are determined. Notch processing is performed on the dense current distribution, and cup branches are added above the ground plate to achieve the WLAN band notch characteristics. A SIR structure is embedded to realize the X-band notch. The design process of the decoupling structure of the antenna is shown in Figure 3. Firstly, add a strip branch on the back of the antenna, then etch a strip gap on the basis of Figure 3(a) to vertically cut the strip branch in Figure 3(b). The antenna size designed in this paper is shown in Table 1 after optimization.

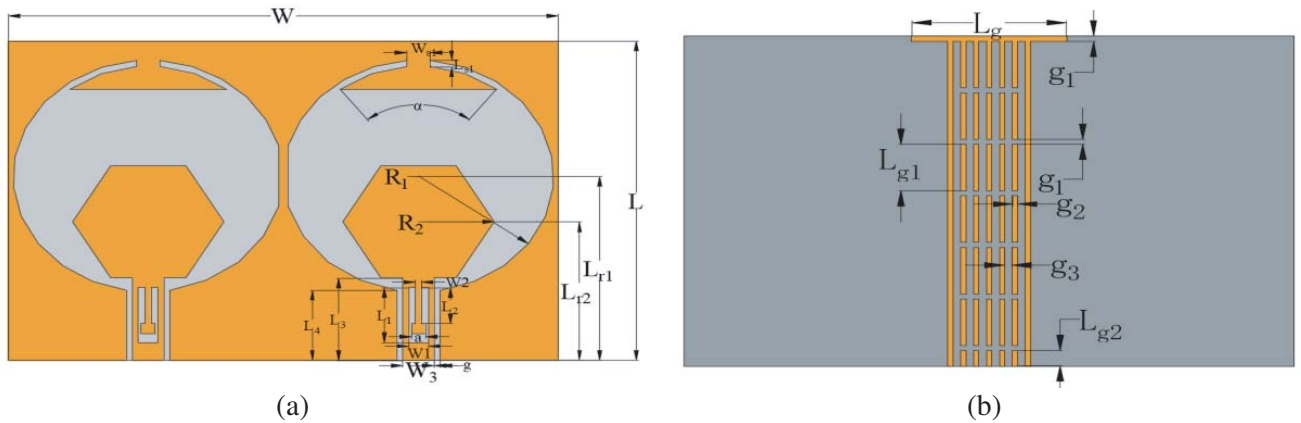
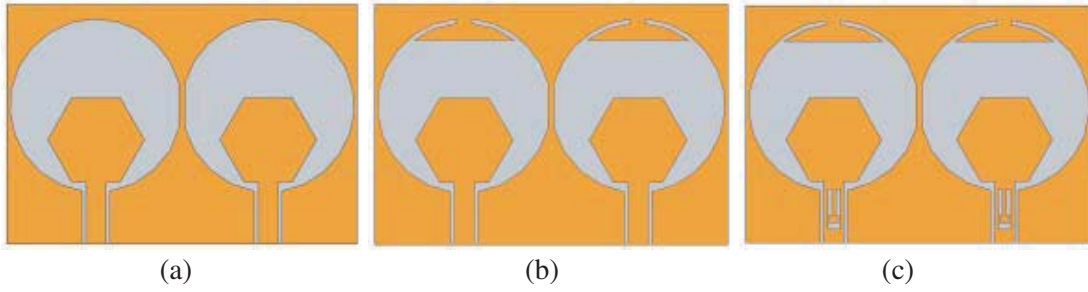

**Figure 1.** Geometry of the proposed antenna. (a) Top view. (b) Bottom view.

## 3. SIMULATION AND ANALYSIS OF THE ANTENNA

Figure 4 shows the effect of various parameters on the center frequency of the band-notched. As can be seen from Figure 4,  $\alpha$  determines the size of the resonant cavity formed by the cup-shaped branch and ground plate. When  $\alpha = 77^\circ$ , the WLAN notch band shows the best performance. When changing the value of  $\alpha$ , the center frequency of the band-notched structure will change accordingly. When  $a = 1.2$  mm, the X notch band shows the best performance.

Figure 5 shows the Voltage Standing Wave Ratio (VSWR) of antennas 1, 2, and 3. It can be seen from the figure that the antenna band-notched characteristics are better, and the influence between



**Figure 2.** Design process of the UWB MIMO antenna. (a) Antenna 1. (b) Antenna 2. (c) Antenna 3.

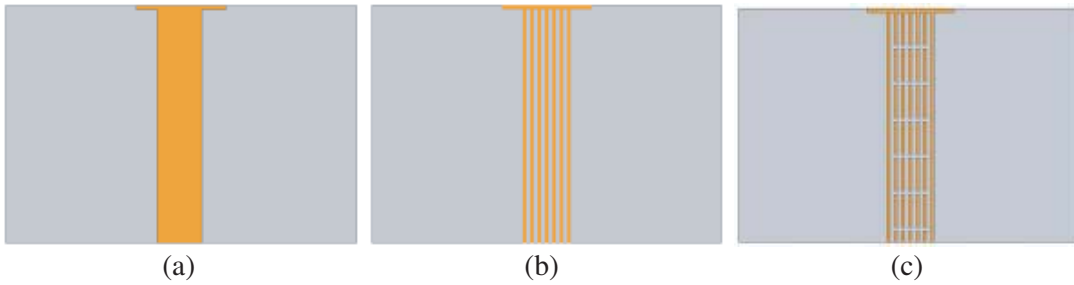

**Figure 3.** Design process of the decoupling structure.

**Table 1.** Geometrical parameters of the proposed antenna (Unit: mm).

Parameter	Value/mm	Parameter	Value/mm	Parameter	Value/mm
$L$	32	$W2$	0.5	$g1$	0.5
$W$	24	$W3$	2.7	$g2$	0.4
$L1$	5.5	$Ws1$	2	$g3$	0.6
$L2$	3.6	$Ls1$	0.6	$Lg$	12
$L3$	18.5	$S1$	14	$Lg1$	4.5
$Lr1$	18.5	$g$	0.5	$Lg2$	1.5
$Lr2$	13.9	$\alpha$	$77^\circ$	$R1$	11.6
$W1$	1.7	$a$	1.2	$R2$	6.5

the band-notched structures is small. It can be seen from Figure 5 that  $VSWR < 2$  in the operating frequency band of antenna 1 and  $VSWR > 2$  in the 5.15–5.825 GHz of antenna 2. It shows that antenna 2 has achieved good notch characteristics in this band. Compared with antenna 2, antenna 3 achieves a notch of 7–7.8 GHz. Figure 6 shows the  $S_{12}$  comparison results of the three decoupling structures. It can be seen from the figure that structure 1 has poor isolation in the operating frequency band. By etching the strip-shaped gap in structure 2, the isolation of the middle frequency band is reduced, but the isolation of the low frequency band is not significantly improved. Structure 3 vertically cuts the bar-shaped branches in structure 2, so that the overall antenna  $S_{12} < -20$  dB, and has no significant impact on VSWR, which meets the requirements of MIMO systems.

Envelope correlation coefficient (ECC) is an important parameter to characterize the performance of a MIMO antenna. In practical applications, an ECC value below 0.5 indicates that the antenna has

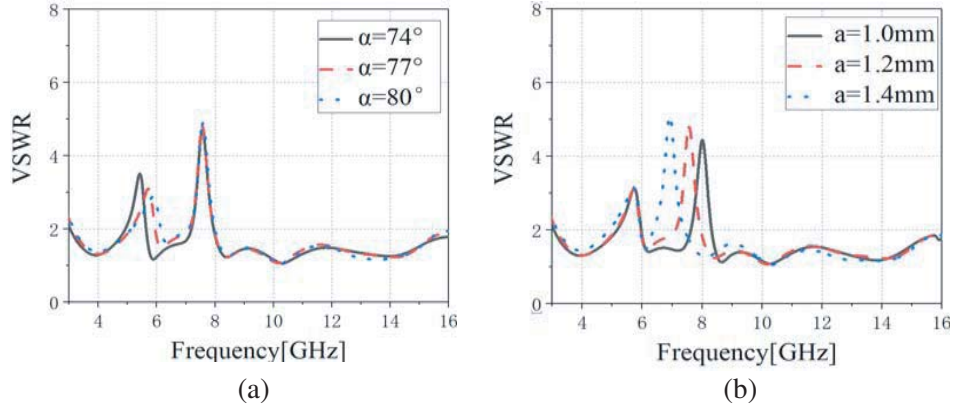

**Figure 4.** The influence of each parameter on the notch frequency. (a)  $\alpha$ . (b)  $a$ .

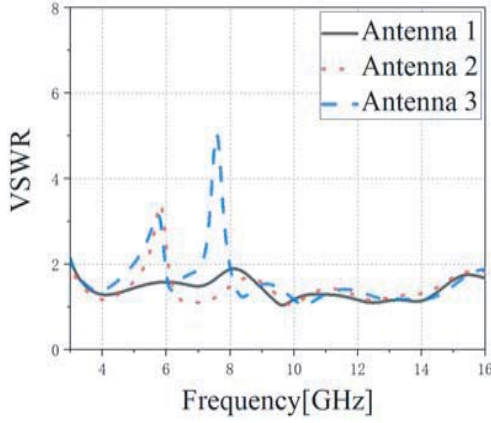

**Figure 5.** The simulated VSWR characteristic of the proposed antenna.

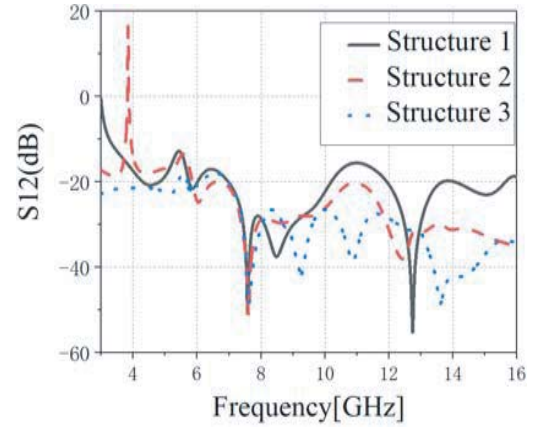

**Figure 6.** The influence of various structures on the proposed antenna

better diversity performance. For MIMO antennas, ECC is calculated using [14]

$$ECC = \frac{|S_{11}^* S_{12} + S_{21}^* S_{22}|^2}{(1 - |S_{11}|^2 - |S_{21}|^2)(1 - |S_{22}|^2 - |S_{12}|^2)}$$

Figure 7 shows the simulated ECC value of the antenna. As can be seen from the figure,  $ECC < 0.025$  in the antenna operating frequency band and rises to about 0.1 in the notch frequency band. The gain variation is shown in Figure 8 with and without the band-notched structure. The magnitude of the gain becomes negative at the centre frequency of WLAN and X band. It can be found that the gain of the antenna is greater than 4 dB in the non-notched band, and it increases with the frequency. In the notch band, the antenna gain decreases sharply and is less than  $-2$  dB, which indicates that antenna 3 has better band-notched characteristics.

The simulated magnetic current distributions of the proposed antenna at 5.5 GHz and 7.5 GHz are shown in Figure 9. It can be observed that the current is mainly distributed near the two band-notched structures; radiation is deteriorated; and the dual band-notched characteristics are realized. The current distribution on the decoupling structure of the backplane is small, indicating that the structure does not significantly affect the performance of the antenna while reducing the isolation.

In order to better analyze the performance of the proposed antenna, the results here are compared with other works in the same field. Comparison between the proposed antenna and existing antennas is shown in Table 2, which includes antenna size, bandwidth, rejected band, and design technique.

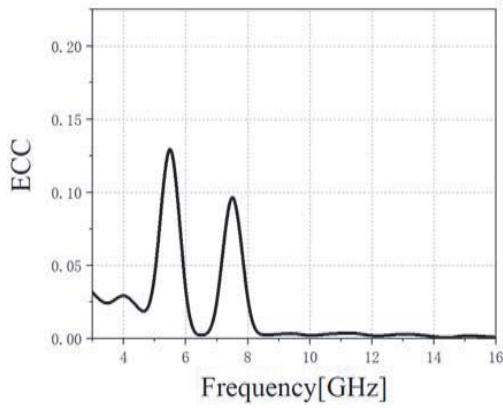

Figure 7. ECC Variation with frequency.

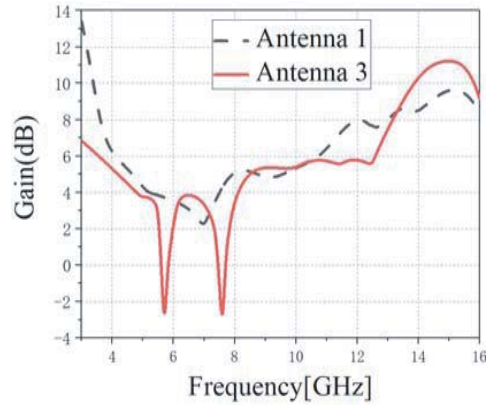

Figure 8. Gain of the proposed antenna.

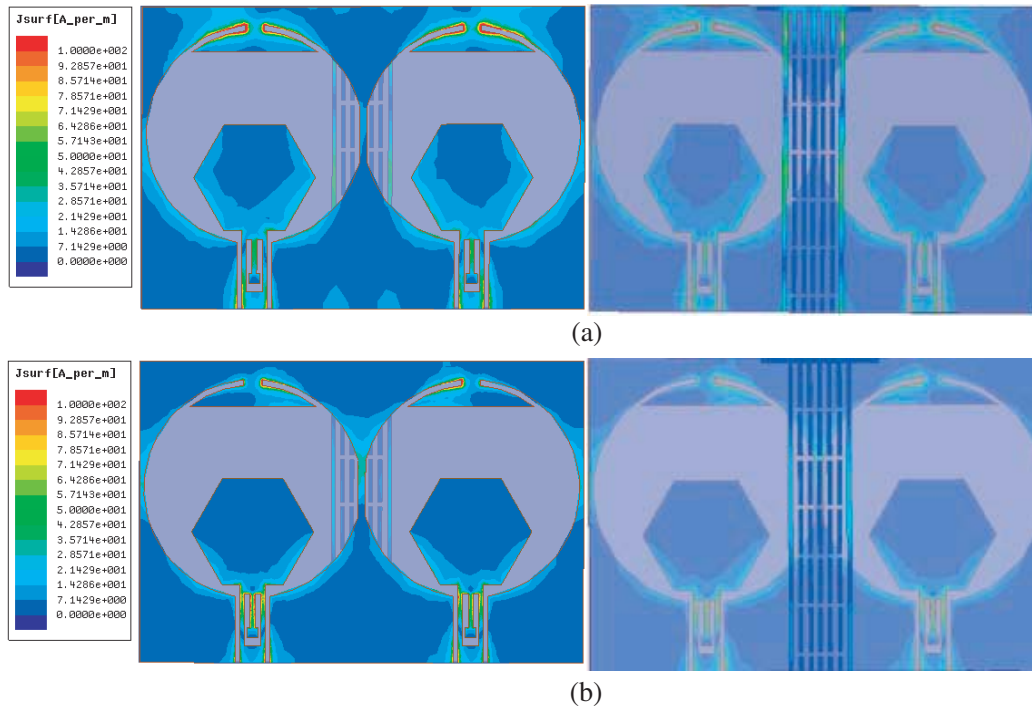

Figure 9. Surface current distribution of the proposed antenna. (a) 5.5 GHz. (b) 7.5 GHz

Table 2. Comparison between existing and proposed band-notched UWB antennas.

<i>Antenna</i>	<i>Size (mm<sup>3</sup>)</i>	<i>Bandwidth (GHz)</i>	<i>Rejected band Technique</i>
[2]	12 × 21 × 0.8	3.1–10.6	U-shaped strip, T-shaped stub
[4]	29 × 38 × 1.6	2.6–12	A fractal slot
[13]	26 × 40 × 0.8	2.2–11.4	U-shaped Slot
[15]	45 × 58 × 1.6	2.8–10.6	DG-CEBG
[16]	22 × 26 × 0.8	3.1–11.8	Trident-shape strips
Proposed	32 × 46 × 1.6	3.1–16	A cup-shaped branch, SIR



### 4. ANTENNA PROCESSING AND TESTING

To validate the proposed design, a prototype is fabricated, as shown in Figure 10. Figure 10(a) shows the comparison between the results of VSWR measurement and simulation of the antenna. The working

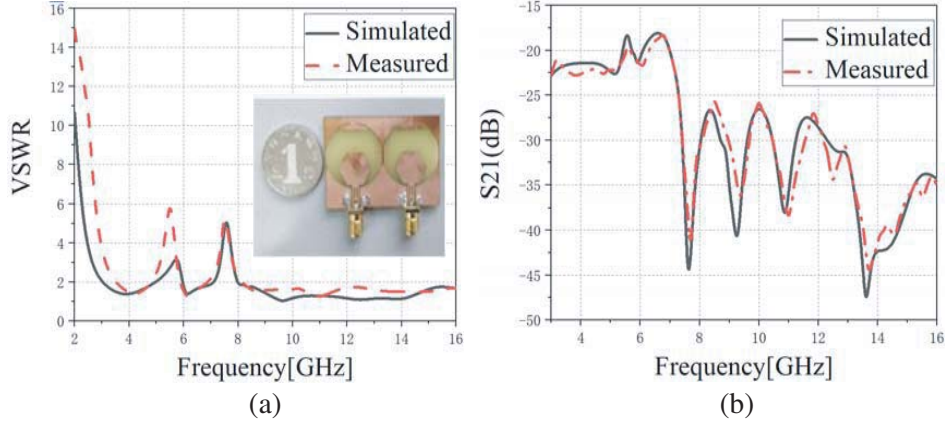

**Figure 10.** Simulated and measured differential parameters of the proposed antenna.

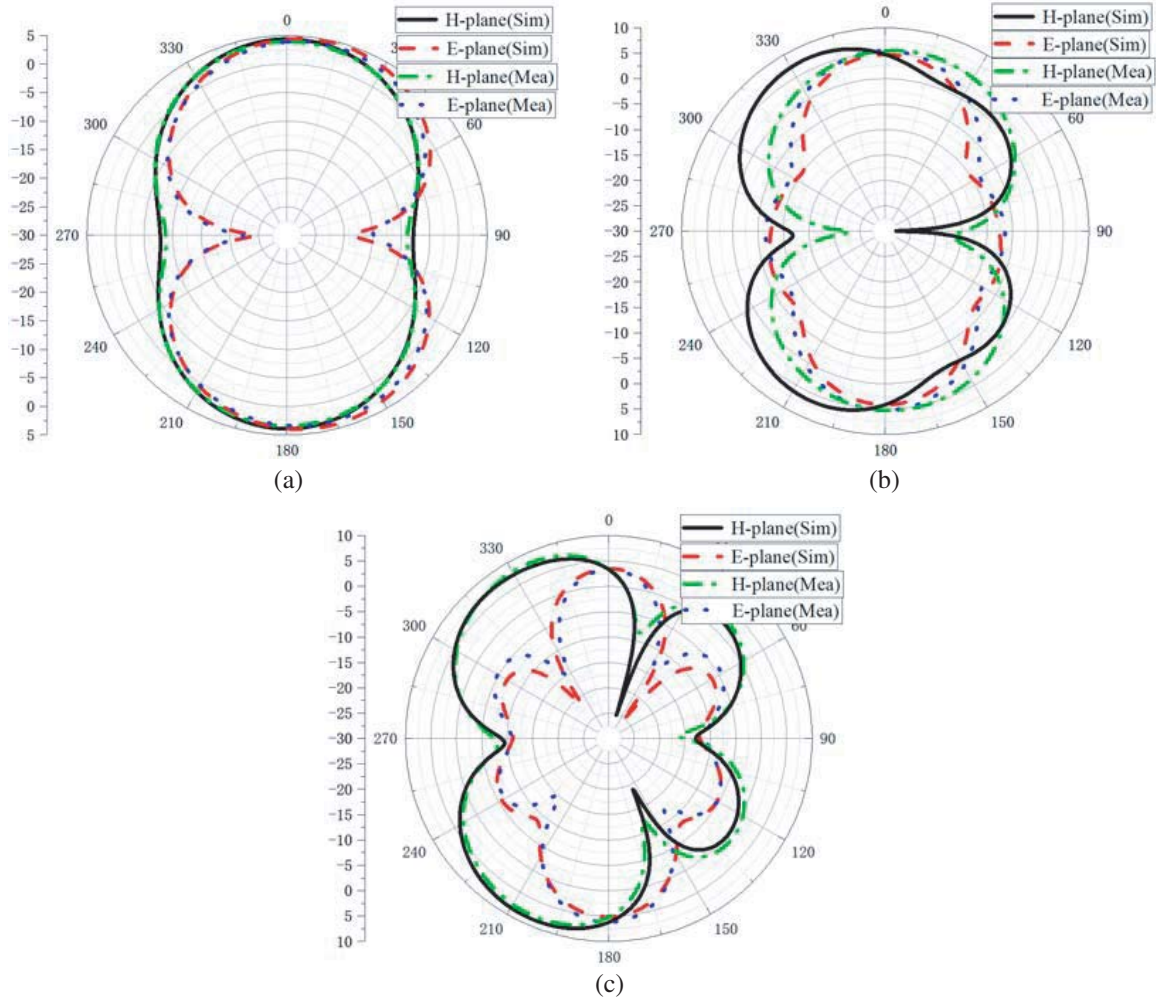

**Figure 11.** Radiation patterns of the antenna, (a) 4.5 GHz, (b) 6.5 GHz, (c) 9.5 GHz.

bandwidth of the antenna simulation results is  $3 \sim 16$  GHz, and the notch bands are  $4.95 \sim 5.85$  GHz and  $7.24 \sim 7.87$  GHz, respectively. The measurement results of the antenna are in good agreement with the simulation ones. The deviation is due to processing errors, and SMA joint welding will lead to changes in test results. Figure 10(b) shows the comparison between test results and simulation results of the antenna.

Figure 11 shows the  $E$  and  $H$  plane radiation patterns of the proposed UWB MIMO antenna at 4.5 GHz, 6.5 GHz, and 9.5 GHz. It is noted from the radiation pattern that the gain of the antenna in the test frequency is more than 3 dB, and it shows good radiation characteristics in the expected operating frequency band. In addition, the radiation pattern deteriorates at higher frequencies due to the splitting of the radiation lobes.

## 5. CONCLUSION

This paper presents a novel dual band-notched CPW-fed UWB MIMO antenna with mutual coupling reduction characteristics. The proposed antenna has a compact size of  $46 \text{ mm} \times 32 \text{ mm} \times 1.6 \text{ mm}$ . By adding cup-shaped branches above the ground plate and adding SIR to the microstrip line, the antenna can generate adjustable band-notched characteristics in the WLAN and X-band downlink frequency band. By adding periodic strip branches on the back of the antenna, good isolation between the two antennas is achieved, which meets the current application requirements of UWB MIMO antennas. The measurement results show that except for the notch band, the impedance bandwidth is extended by using CPW feeding, ranging from 3 GHz to 16 GHz, which is better than most UWB antennas and is an ideal choice for future UWB communication systems.

## REFERENCES

1. Federal Communications Commission, "First report and order in the matter of revision of part 15 of the the Commission's Rules Regarding Ultra-Wideband Transmission Systems," FCC02-48, Federal Communications Commission, Washington, DC, USA, 2002.
2. Jetti, C. R. and V. R. Nandanavanam, "A very compact MIMO antenna with triple band-notch function for portable UWB systems," *Progress In Electromagnetics Research C*, Vol. 82, 13–27, 2018.
3. Tao, J. and Q. Feng, "Compact ultrawideband MIMO antenna with half-slot structure," *IEEE Antennas Wireless Propag. Lett.*, Vol. 16, 792–795, 2017.
4. Tripathi, S., A. Mohan, and S. K. Yadav, "A compact MIMO/diversity antenna with WLAN band notch characteristics for portable UWB applications," *Progress In Electromagnetics Research C*, Vol. 77, 29–38, 2017.
5. Sharma, M., Y. K. Awasthi, H. Singh, R. Kumar, and S. Kumari, "Compact UWB antenna with high rejection triple band-notch characteristics for wireless applications," *Wireless Pers. Commun.*, Vol. 97, No. 3, 4129–4143, 2017.
6. Wang, S., "A new compact printed triple band-notched UWB antenna," *Progress In Electromagnetics Research Letters*, Vol. 58, 67–72, 2016.
7. Chandel, R., A. K. Gautam, and K. Rambabu, "Tapered fed compact UWB MIMO-diversity antenna with dual band-notched characteristics," *IEEE Trans. Antennas Propagat.*, Vol. 66, No. 4, 1677–1684, Apr. 2018.
8. Zhu, J., B. Feng, B. Peng, L. Deng, and S. Li, "Dual notched band MIMO slot antenna system with Y-shaped defected ground structure for UWB applications," *Microwave and Opt. Tech. Lett.*, Vol. 58, No. 3, 626–630, 2016.
9. Chandel, R. and A. K. Gautam, "Tapered fed compact UWB MIMO — Diversity antenna with dual band-notched characteristics," *IEEE Trans. Antennas Propagat.*, Vol. 66, No. 4, Apr. 2018.
10. Zhu, J., S. Li, B. Feng, et al., "Compact dual-polarized UWB quasi-self-complementary MIMO/diversity antenna with band-rejection capability," *IEEE Antennas and Wireless Propagation Letters*, Vol. 15, 905–908, 2016.

11. Li, Z., C. Yin, et al., "Compact UWB MIMO vivaldi antenna with dual band-notched characteristics," *IEEE Access*, Vol. 7, 38696–38701, Apr. 2019.
12. Tang, Z., X. Wu, et al., "Compact UWB-MIMO antenna with high isolation and triple band-notched characteristics," *IEEE Access*, Vol. 7, 19856–19865, Feb. 2019.
13. Tao, J. and Q. Feng, "Compact UWB MIMO vivaldi antenna with dual band-notched characteristics," *Progress In Electromagnetics Research C*, Vol. 88, 1–12, 2018.
14. Blanch, S., J. Romeu, and I. Corbella, "Exact representation of antenna system diversity performance from input parameter description," *Electronics Letters*, Vol. 39, No. 9, 705–707, May 1, 2003.
15. Jaglan, N., S. D. Gupta, and B. K. Kanaujia, "Triple band notched DG-CEBG structure based UWB MIMO/diversity antenna," *Progress In Electromagnetics Research C*, Vol. 80, 21–37, 2018.
16. Jetti, C. R. and V. R. Nandanavanam, "Trident-shape strip loaded dual band-notched UWB MIMO antenna for portable device applications," *AEU — International Journal of Electronics and Communications*, Vol. 83, 11–21, 2017.