

## Conformal Wideband Microstrip Patch Antennas on Cylindrical Platforms

Tanzeela Mitha and Maria Pour\*

**Abstract**—A conformal wideband antenna is investigated and compared with its planar counterpart. First, a planar U-slot patch with about 43% fractional impedance bandwidth is designed. Then, it is mounted on a conformal cylindrical structure. It is observed that the fractional impedance bandwidth of the resulting conformal antenna increases to 50%, when it is bent along the  $H$ -plane. It is also found that the cross polarization discrimination of the antenna is improved. The effects of the arc angle and radius of the cylinder on the impedance bandwidth and radiation characteristics of the antenna are extensively studied. The conformal antenna was fabricated on a thin film of Kapton and tested. The measured and simulated results closely resembled each other.

### 1. INTRODUCTION

Microstrip patch antennas are light weight and low profile antennas that are inherently narrowband in the order of 1%–2% [1]. In emerging wireless communications and radar systems, however, large bandwidths are necessary to transmit massive amounts of data and to enhance the resolution in radar systems. Hyung and Lee [2] proposed a novel technique to increase the bandwidth of single-layer patch antennas to 30% by cutting a U-shaped slot from the patch. The U-slot antenna has been further studied and analyzed to develop design procedures [3, 4] to estimate the structure's multiple resonating frequencies that are eventually coupled together to widen the frequency band. Recent advances in the field of wearable technology have created a strong demand for antennas that are flexible and mechanically robust for long-time use. The bending effects on the rectangular patch antenna were studied for wearable applications in [5–11]. A cylindrical-rectangular cavity model for bent patch antennas was analyzed in [10, 11]. In [5, 6], the bending effects of narrow- and multi-band patch antennas on the input impedance, resonant frequencies, and radiation performance were studied, where the shift in the resonant frequencies was well explicated. However, the bending effect on the impedance bandwidth of wideband antennas has not been investigated, to the best of our knowledge.

In this letter, a planar U-slot microstrip patch antenna is first designed to provide about 43% impedance bandwidth. Later, this wideband antenna is mounted on a cylindrical conformal structure to further investigate its impedance bandwidth and radiation characteristics. The fractional impedance bandwidth is calculated by  $\frac{f_H - f_L}{f_C} \times 100$ , where  $f_H$ ,  $f_L$  and  $f_C$  represent the high, low and central frequency of the  $-10$  dB impedance bandwidth. The antenna properties such as gain, reflection coefficients, radiation patterns, and cross polarization are studied by varying the curvature parameters such as the arc angle and the radius of the cylinder. The impedance bandwidth of the conformal patch antenna bent along the  $H$ -plane, i.e., the patch width, increases to about 50% with an enhanced cross polarization performance in the order of  $-15$  dB at the diagonal plane, which is 5 dB smaller than its planar wideband antenna counterpart. The measured frequency response and radiation patterns of the conformal antenna show good agreement with the simulated results.

---

Received 9 October 2018, Accepted 26 October 2018, Scheduled 8 November 2018

\* Corresponding author: Maria Pour (maria.pour@uah.edu).

The authors are with the Department of Electrical and Computer Engineering, The University of Alabama in Huntsville, Huntsville, AL 35899, USA.

## 2. ANTENNA CONFIGURATION

A narrowband microstrip antenna consists of a radiating patch on one side of a thin dielectric substrate and a ground plane on the other side. Wideband behavior is realized by cutting a U-shaped slot from the patch [2], based on which a planar rectangular U-slot is designed in the X-band on a grounded dielectric substrate with a height of 3.175 mm and dielectric constant of  $\epsilon_r = 1$ . The dimensions of the patch and the ground plane are  $21.5 \times 10.5 \text{ mm}^2$  and  $44.4 \times 44.4 \text{ mm}^2$ , respectively. A 1 mm U-shaped slot is cut in the center of the patch. The vertical and horizontal lengths of the slot are 6.8 mm and 7.6 mm, respectively. The patch is excited by a  $50 \Omega$  coaxial probe, which is located at 0.3 mm off the center of the patch. The planar patch is numerically finalized to obtain about 43% impedance bandwidth. This U-slot patch antenna is then mounted on a cylindrical structure with a radius  $r$  and an arc angle  $\alpha$ , as shown in Fig. 1, where the antenna is bent along its  $H$ -plane, i.e., the patch width. The planar and conformal wideband antennas are numerically analyzed using a finite-element based full-wave electromagnetic solver, ANSYS HFSS v.16 [12]. The scattering parameters,  $|S_{11}|$ , for the planar and conformal antennas bent along the  $E$ - (length of the patch) and  $H$ -planes (width of the patch) are plotted and compared in Fig. 2. It is observed that bending the antenna along the  $E$ - and  $H$ -planes increases the antenna bandwidth to  $\sim 47\%$  and  $\sim 50\%$ , respectively. Since the  $H$ -plane bending affects the impedance bandwidth more significantly than the  $E$ -plane bending, the effect of varying the antenna parameters is further investigated for the  $H$ -plane bent for this wideband antenna. The results will be presented in the following section.

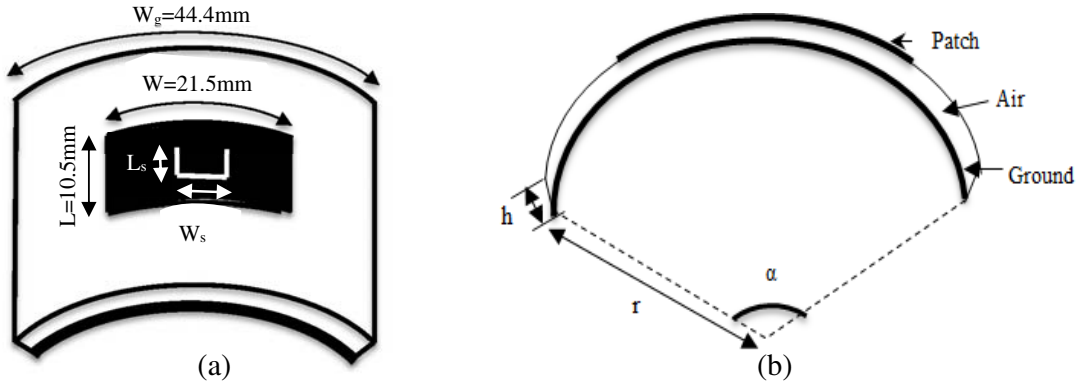

**Figure 1.** (a) Top- and (b) side-view of the conformal wideband antenna, placed on a cylindrical mounting structure and bent along the  $H$ -plane with  $h = 3.175$  mm.

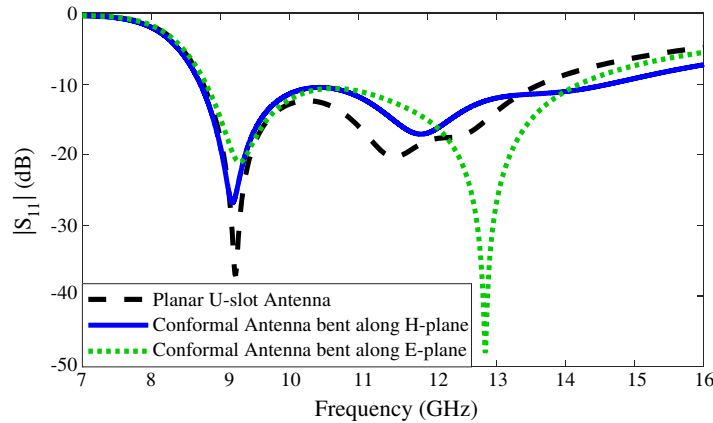

**Figure 2.** Comparison of the reflection coefficients of the planar and conformal U-slot patch antennas bent along the  $E$ - and  $H$ -planes, when  $h = 3.175$  mm,  $\alpha = 100^\circ$ , and  $r = 15$  mm.

### 3. VARYING ANTENNA PARAMETERS

In this section, the effects of the arc angle and radius of the cylinder on the antenna impedance bandwidth are studied. This enables one to determine the best antenna parameters to realize maximum fractional bandwidth without substantially degrading the radiation properties.

#### 3.1. Varying the Arc Angle and the Radius of Curvature of the Conformal Structure

In order to study the effect of the arc angle on the impedance bandwidth of the conformal U-slot patch antenna under investigation, the radius of the cylinder is kept constant at 25 mm, which is almost half of the planar ground plane size, and the arc angle is varied from  $80^\circ$  to  $120^\circ$ . The corresponding reflection coefficients versus frequency are shown in Fig. 3(a). It is observed that as the arc angle changes, the impedance bandwidth increases up to  $\sim 47\%$  when  $\alpha = 100^\circ$  and decreases thereafter. This shows that the conformal U-slot antenna, with the  $100^\circ$  arc angle, has  $\sim 4\%$  more bandwidth than its planar version. The arc angle of the conformal structure is then fixed at  $100^\circ$ , at which it achieves  $\sim 47\%$  impedance bandwidth, and the radius of the cylinder structure is varied from 15 to 35 mm. The results are depicted in Fig. 3(b). As can be seen, the conformal antenna now exhibits much wider impedance bandwidth in the order of  $\sim 50\%$ , when the radius of curvature is equal to 15 mm. Thus, this conformal structure improves the bandwidth by 7% compared to its planar counterpart. This is mainly attributed to the larger volume of the conformal antenna, reducing the antenna quality factor [11], and thus widening the impedance bandwidth.

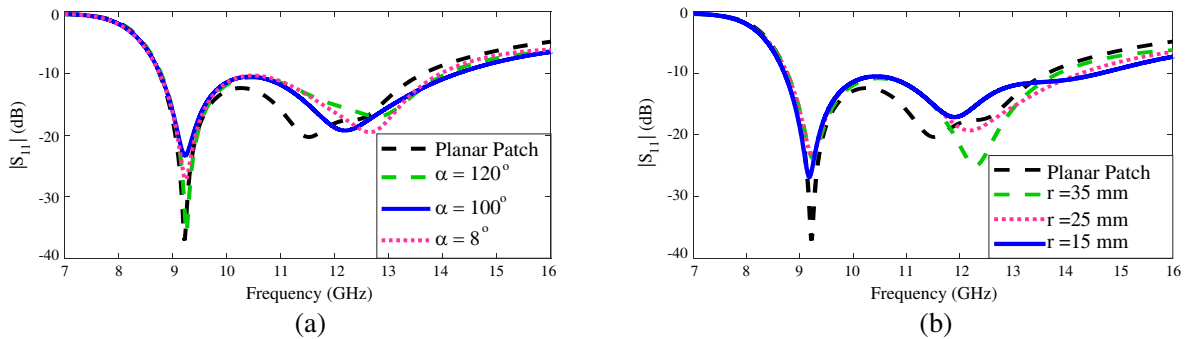

**Figure 3.** Reflection coefficients of the conformal U-slot antenna in Fig. 1 with (a)  $r = 25$  mm, as  $\alpha$  varies from  $80^\circ$  to  $100^\circ$  and (b)  $\alpha = 100^\circ$ , as  $r$  changes from 15 mm to 35 mm.

### 4. THE RADIATION PATTERNS AND CROSS POLARIZATION

It is instructive to compare the radiation patterns of the planar U-slot patch antenna with those of the conformal antenna bent along the  $H$ -plane. As representative examples, the co-polar radiation patterns at the principal planes and the cross-polar radiation pattern at the  $\phi = 45^\circ$  are plotted in Figs. 4 and 5 for the planar and conformal U-slot antennas, respectively, at frequencies of 9.5 GHz and 11.5 GHz. It is observed that the peak gain of the conformal wideband antenna is about 1 dB smaller than the planar antenna. This is expected, as the overall projected aperture area becomes smaller, when the patch is mounted on the conformal structure. The projected aperture area of the antenna reduces further when the curvature of the conformal structure is increased. This results in a gain drop, which in turn widens the main beam of the radiation pattern. However, the conformal antenna does not show much variation in the antenna radiation profile, compared to its planar counterpart. That is, the overall radiation pattern of the conformal antenna remains broadside, similar to the planar U-slot antenna, as illustrated in Figs. 4 and 5. Interestingly, it is found that the cross polarization component of the conformal U-slot patch antenna is 5 dB smaller than that of the planar U-slot antenna, thus improving the antenna polarization performance. It is worth mentioning that the aforementioned improved cross

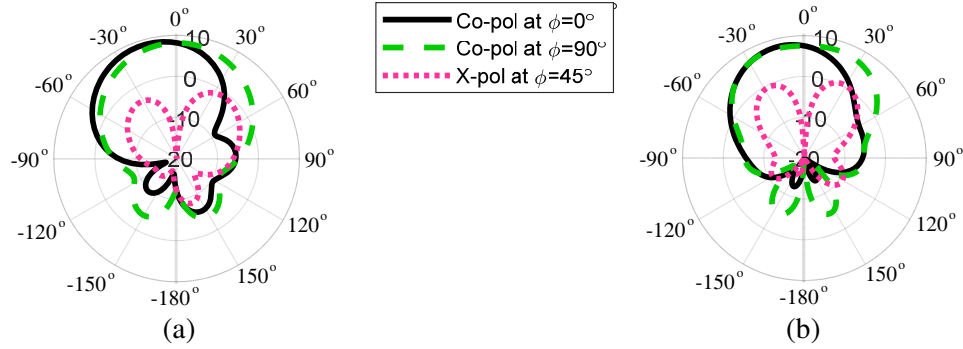

**Figure 4.** Co-polar radiation patterns at the principal planes and cross-polar radiation pattern at the  $\phi = 45^\circ$  of planar U-slot patch antenna at (a) 9.5 GHz and (b) 11.5 GHz.

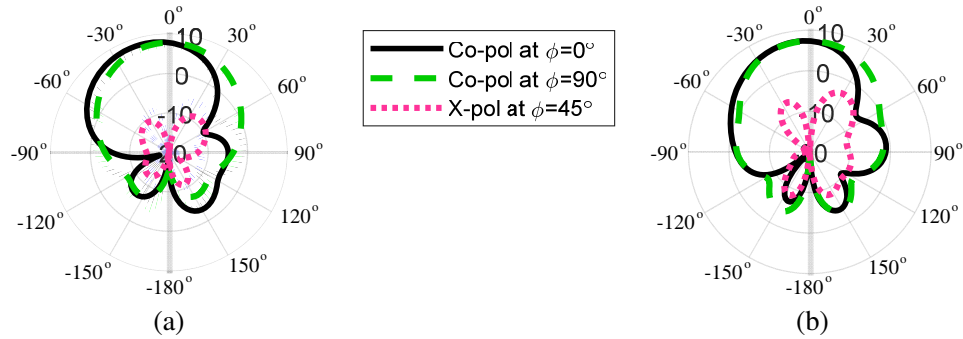

**Figure 5.** Co-polar radiation patterns at the principal planes and cross-polar radiation pattern at  $\phi = 45^\circ$  of the conformal U-slot patch antenna at (a) 9.5 GHz and (b) 11.5 GHz.

polarization occurs at the diagonal plane, at which the cross polarization reaches to its maximum level based on Ludwig's 3rd definition [13]. The improved cross polarization discrimination is mainly due to the partial cancellation of the decomposed cross polarization components due to the curvature of the mounting structure. As the frequency increases beyond 13.5 GHz, higher order modes are excited, resulting in saddle-shaped radiation patterns in the conformal antenna. This change in the radiation pattern occurs for the planar structure at 12.5 GHz. Thus, the bandwidth of the conformal antenna, within which the radiation pattern is broadside is  $\sim 42\%$  and that of the planar U-slot patch is  $\sim 35\%$ .

## 5. EXPERIMENTAL RESULTS

The proposed conformal U-slot antenna was fabricated using a copper adhesive tape on a thin film of Kapton 150FN019 as shown in Figs. 6(a) and (b). In order to facilitate manufacturing and assembly processes, slight modifications were made in the antenna design as follows. The patch and ground were separated by a Styrofoam of thickness  $\sim 3.2$  mm and conformed to a cylindrical shape with  $r = 18.9$  mm and  $\alpha = 100^\circ$ . The ground plane size was reduced to 33 mm. The measured and simulated reflection coefficients of the conformal wideband antenna are shown in Fig. 6(c). The measured  $S_{11}$  follows the same trend as the simulated one, resulting in about 50% impedance bandwidth in practice. It should be mentioned that the discrepancy between the results, especially over the mid-frequency range, is mainly attributed to the non-uniformity of the Styrofoam thickness, occurred in the manual assembly, and fabrication errors.

The co-pol and cross-pol radiation patterns of the fabricated antenna are compared to the simulated ones at 9.5 GHz and 11.5 GHz in Fig. 7. Overall, the radiation patterns of the fabricated antenna are in good agreement with the simulated ones. However, there are small discrepancies between the measured and simulated radiation patterns, which are mainly due to the aforementioned assembly and fabrication

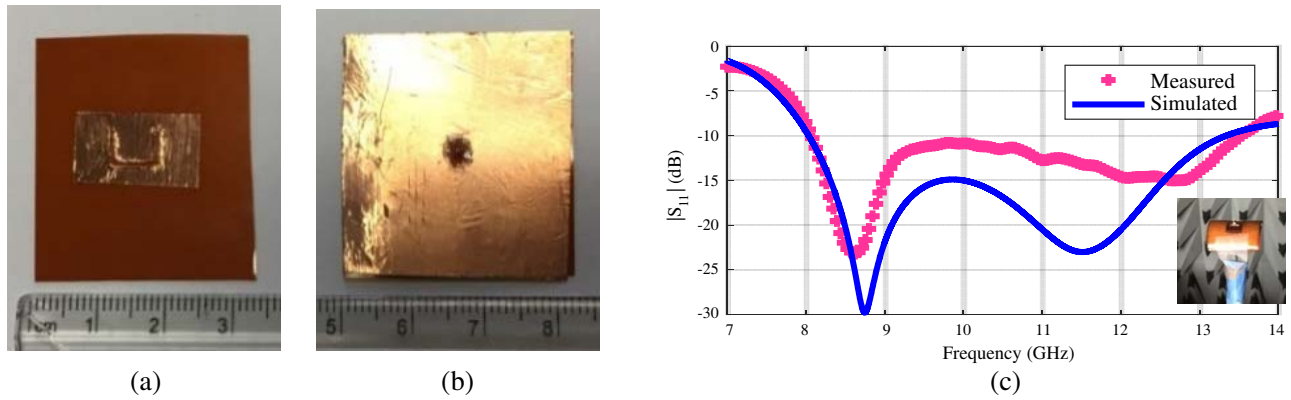

**Figure 6.** (a) Top and (b) bottom of the fabricated U-slot antenna made from adhesive copper tape placed on 150FN019 Kapton film and (c) simulated and measured  $S_{11}$  of the conformal U-slot antenna with  $\epsilon_r = 1$ ,  $r = 15$  mm, and  $\alpha = 100^\circ$ .

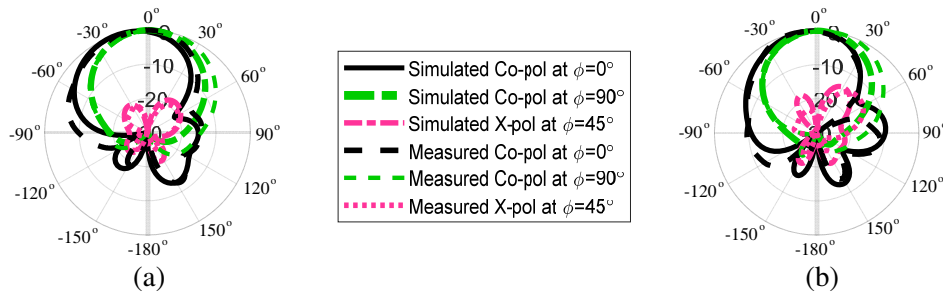

**Figure 7.** Measured and simulated co-polar radiation patterns at the principal planes and cross-polar radiation patterns at the  $\phi = 45^\circ$  plane (a) 9.5 GHz and (b) 11.5 GHz.

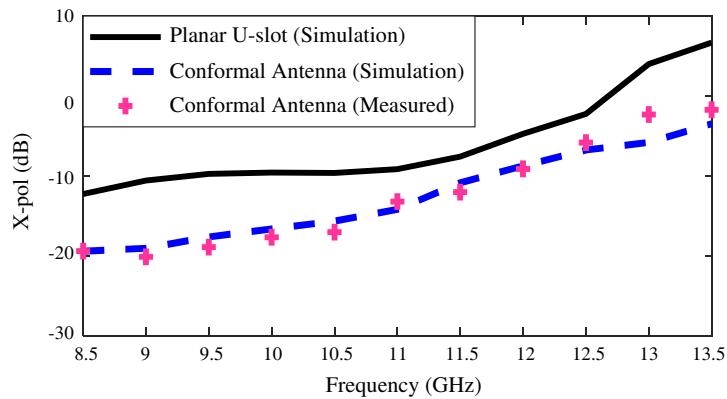

**Figure 8.** Simulated and measured cross polarization at the  $\phi = 45^\circ$  plane for the planar and conformal antenna over the frequency range, within which the conformal antenna shows broadside radiation patterns.

issues, as well as the effect of the connecting cable. On average, the maximum cross polarization at the diagonal plane for the broadside radiation patterns of the simulated and fabricated conformal antennas is 5 dB smaller than the planar U-slot antenna as depicted in Fig. 8. The measured results show the same trend as that of the simulated results.

## 6. CONCLUSION

The characteristics of a wideband conformal U-slot microstrip patch antenna were investigated and compared to its planar counterpart. The antenna parameters of the conformal structure were varied to determine the structure that resulted in a wider impedance bandwidth than its planar counterpart. In particular, the conformal antenna had a bandwidth of about 50%, which was 7% more than the planar structure and cross polarization of  $-15$  dB that was 5 dB smaller than its planar counterpart. The measured frequency response and radiation patterns of the conformal wideband antenna closely resembled the simulated ones. In conclusion, conformal U-slot patch antennas can be effectively designed to further enhance their impedance bandwidth and cross-polarization characteristics. With the additive printing technology, such conformal wideband antennas can be easily fabricated on curved, flexible dielectric materials for structural health monitoring applications.

## ACKNOWLEDGMENT

This work was supported in part by the National Science Foundation (NSF) CAREER Award No. ECCS-1653915.

## REFERENCES

1. Balanis, C. A., *Antenna Theory: Analysis and Design*, 4th edition, John Wiley, Hoboken, NJ, 2016.
2. Huynh, T. and K.-F. Lee, "Single-layer single-patch wideband microstrip antenna," *Electron. Lett.*, Vol. 31, No. 16, 1310–1312, Aug. 1995.
3. Weigand, S., G. H. Huff, K. H. Pan, and J. T. Bernhard, "Analysis and design of broad-band single-layer rectangular U-slot microstrip patch antennas," *IEEE Trans. Antennas Propag.*, Vol. 51, No. 3, 457–468, Mar. 2003.
4. Tong, K.-F., K.-M. Luk, K.-F. Lee, and R. Q. Lee, "A broad-band U-slot rectangular patch antenna on a microwave substrate," *IEEE Trans. Antennas Propag.*, Vol. 48, No. 6, 954–960, Jun. 2000.
5. Salonen, P. and Y. Rahmat-Samii, "Textile antennas: Effects of antenna bending on input matching and impedance bandwidth," *IEEE Aerosp. Electron. Syst. Mag.*, 10–14, Mar. 2007.
6. Song, L. and Y. Rahmat-Samii, "A systematic investigation of rectangular patch antenna bending effects for wearable applications," *IEEE Trans. Antennas Propag.*, Vol. 66, No. 5, 2219–2228, May 2018.
7. Liu, F.-X., T. Kaufmann, Z. Xu, and C. Fumeaux, "Wearable applications of quarter-wave patch and half-mode cavity antennas," *IEEE Antennas Wireless Propag. Lett.*, Vol. 14, 1478–1481, 2015.
8. Ashyap, A., Z. Abidin, S. Dahlan, H. Majid, M. Kamarudin, G. Oguntala, R. A. Abd-Alhameed, and J. Noris, "Inverted E-shaped wearable textile antenna for medical applications," *IEEE Access*, Vol. 6, 35214–35222, Jun. 2018.
9. Macon, C. A., K. D. Trott, and L. C. Kempel, "A practical approach to modeling doubly curved conformal microstrip antennas," *Progress In Electromagnetics Research*, Vol. 40, 295–314, 2003.
10. Krowne, C. M., "Cylindrical-rectangular microstrip antenna," *IEEE Trans. Antennas Propag.*, Vol. 31, No. 1, 194–199, Jan. 1983.
11. Luk, K., K.-F. Lee, and J. S. Dahele, "Analysis of the cylindrical rectangular patch antenna," *IEEE Trans. Antennas Propag.*, Vol. 37, No. 2, 143–147, Feb. 1989.
12. "ANSYS high frequency electromagnetic field simulator HFSS (version 18.1)," Canonsburg, PA.
13. Ludwig, A., "The definition of cross polarization," *IEEE Trans. Antennas Propag.*, Vol. 21, No. 1, 116–119, Jan. 1973.