

## APERTURE AND MUTUAL COUPLED CYLINDRICAL DIELECTRIC RESONATOR ANTENNA ARRAY

Affan A. Baba<sup>1, \*</sup>, Mohammad A. Zakariya<sup>1</sup>,  
Zuhairi Baharudin<sup>1</sup>, Mohd H. M. Khir<sup>1</sup>,  
Muhd. Z. Ur Rehman<sup>1</sup>, Zainal A. Ahmad<sup>2</sup>,  
and Yazeed M. Qasaymeh<sup>2</sup>

<sup>1</sup>Electrical and Electronics Engineering Department, Universiti Teknologi PETRONAS, Malaysia

<sup>2</sup>School of Electrical and Electronics, Material and Mineral Resources Engineering, Universiti Sains Malaysia, Penang 14300, Malaysia

**Abstract**—A  $1 \times 3$  element linear array using cylindrical dielectric resonator antennas (CDRAs) is designed and presented for 802.11a WLAN system applications. The top and bottom elements of CDRA array are excited through the rectangular coupling slots etched on the ground plane, while the slots themselves are excited through the microstrip transmission line. The third element (i.e., central CDRA) is excited through the mutual coupling of two radiating elements by its sides. This mechanism enhances the bandwidth (96.1%) and gain (14.3%) as compared to aperture coupled technique. It is also observed that the side lobe levels are reduced over the designed frequency band. Using CST microwave studio, directivity of 10.5 dBi has been achieved for operating frequency of 5.6 GHz. Designed antenna array is fabricated and tested. Simulated and measured results are in good agreement. The equivalent lumped element circuit is also designed and presented using Advanced design system (ADS) for this proposed array.

### 1. INTRODUCTION

There is growing interest in microstrip patch antenna technology in various wireless applications due to its low profile and small antenna size. The microstrip patch antenna advantageous features include small size, low cost and ease of fabrication. While at millimeter

---

*Received 11 January 2013, Accepted 16 February 2013, Scheduled 18 February 2013*

\* Corresponding author: Affan Aziz Baba (babaaffan88@gmail.com).

wave frequencies it has conductor and surface wave losses that degrade the patch antenna's performance in terms of its gain. The dielectric resonator antenna (DRA) is considered to be a viable and feasible solution to the conventional conductor antennas at millimeter wave frequencies with its low conductor and surface wave losses especially compared to the microstrip patch antenna [1]. Before the use of DRs in antenna applications [2], DRs of different shapes with high relative permittivity  $\epsilon_r > 20$  have been used in various applications of microwave circuits [3].

In the last two decades, antenna designer's attraction has moved towards the dielectric resonator antenna (DRA) due to its superior performance features such as:

- it can be fabricated using a high dielectric constant material;
- covers wide range of frequency band:  $f = 0.7\text{--}35$  GHz;
- exhibits high radiation efficiency (95%); due to low conductor and surface wave losses;
- excitable through different transmission lines, i.e., microstrip feed line, dielectric image line, coaxial probe;
- the performance of DRAs is minimally effected by the presence of nearby noisy objects (such as human bodies) [4];
- can be fabricated in different shapes, i.e., cylindrical, rectangular, hemispherical.

In general, single element DRA has a broad radiation pattern with limited gain of about  $\sim 5$  dBi [3]. Similar to other conventional low gain antennas, DRAs gain can also be enhanced by using it in an array configuration. Several different shapes of DRAs such as hemispherical, cylindrical, rectangular and circular have been proposed in the literatures [5]. From the literatures, the CDRA is the most widely used technology in spite of several advantages of the rectangular dielectric resonator antenna (RDRA). The reason behinds the researchers attraction toward the CDRA is its simple mode structure as compared to RDRA (i.e., field structure in the RDRA modes is complicated due to a large number of edges involved in its geometry) [6]. The main advantage of CDRA for high gain applications is that, it is more directional as compared to rectangular and annular shaped DRAs [7]. The single element CDRA operating at 5.2 GHz has been proposed in [8]. A gain of 5.45 dBi has been reported in the literature; where CDRA is fed with a stair shaped slot for the resonant frequency of 3.5 GHz [9]. Different types of feeding techniques are available in the literatures i.e., probe feed, microstrip line, and dielectric image guide. Among these feeding techniques, microstrip

transmission line is more attractive due to its low cost, low profile, easy to fabricate and compatibility features with MMIC components [10].

In this paper, a aperture and mutual coupled 3-element array of CDRA fed by aperture coupled microstrip line is presented for 5.0 GHz band applications. The proposed array structure is studied based on Finite Integration Technique (FIT) using a CST microwave studio. In array structure, the distance between the elements and slot sizes are adjusted to achieve the best return loss ( $S_{11} < -10$  dB). The distance between the consecutive radiating elements is  $0.26\lambda_{air}$ , while the distance between two slots is  $0.9\lambda_g$ . Furthermore, in order to achieve an enhanced bandwidth of 1.076 GHz; a central CDRA is introduced and is excited by its neighboring two CDRA's. Simulation results show that the maximum achievable directivity is 10.5 dBi at 5.6 GHz. The results of fabricated design also show that they are in accordance with the simulated results. The lumped element circuit is also designed and presented to predict the behavior of return loss with and without mutual coupling. The comparison between the return losses results from CST, ADS and the fabricated design are also presented.

## 2. CDRA ARRAY DESIGN METHODOLOGY

The complete geometry of the CDRA array operating at 5.0 GHz is depicted in Figure 1 and Table 1. This proposed antenna array comprises of a set of 3 identical CDRA's with diameter  $2a = 15.5$  mm, height  $h_1 = h_2 = h_3 = 3.0$  mm and permittivity  $\epsilon_r = 55$ .

In this proposed array, first and last radiating elements are excited through the aperture coupling technique, while the middle radiating element is excited through the mutual coupling of the remaining two

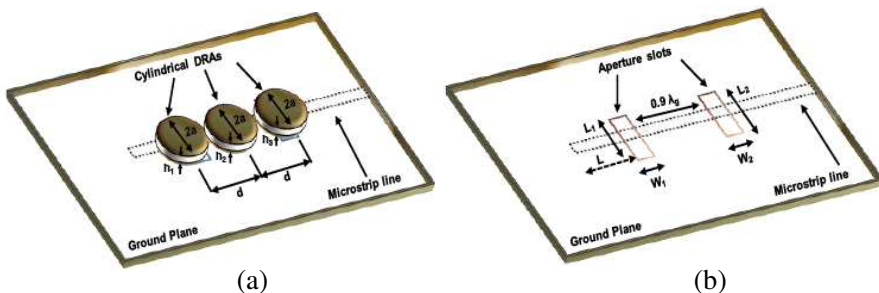

**Figure 1.** The geometry of the CDRA array. (a) Front view and (b) rectangular slots.

**Table 1.** The dimensions of CDRA array.

Label	Length (mm)
$L_1, L_2$	20.0
$w_1, w_2$	4.0
$2a$	15.5
$h_1, h_2, h_3$	3.0
$L$	6.67

elements. The mutual coupling mechanism is used to enhance the array performance. It is clearly mentioned in [11], by using mutual coupling technique array performance can be enhanced in terms of bandwidth and gain. The resonance frequency of the CDRA for  $TE_{011+\delta}$  mode is given as [12]:

$$f_0 = \frac{662.4 \times 10^6}{2\pi a \sqrt{\varepsilon_r + 2}} \left\{ 1 + 0.7013 \left( \frac{a}{h} \right) - 0.002713 \left( \frac{a}{h} \right)^2 \right\} \quad (1)$$

where:

- radius of CDRA,  $a = 7.75$  mm;
- height of CDRA,  $h = 3$  mm;
- dielectric constant  $\varepsilon_r = 55$ .

The geometrical dimensions of the two aperture slots which excites the first and last CDRA's are  $L_1 = L_2 = 20$  mm and width  $w_1 = w_2 = 4$  mm. These two slots are designed on the ground plane of FR4 substrate with a thickness and permittivity of 1.565 mm and 4.9 respectively and are placed at a distance of  $0.9\lambda_g$ . In this array, the distance between the consecutive elements is  $0.26\lambda_{\text{air}}$ . The value of  $\lambda_g$  can be calculated by using the expression found in [5]:

$$\lambda_g = \frac{c}{f\sqrt{\varepsilon_s}} \quad (2)$$

where:

- $c$  speed of light;
- $f$  resonance frequency calculated by using Equation (1);
- $\varepsilon_s$  substrate permittivity.

These two aperture slots are excited through the  $50\ \Omega$  microstrip feed line with a width and length of 2.61 mm and 55 mm respectively. The microstrip line synthesis procedure is used to calculate the width of transmission line. The distance between the first slot and the edge

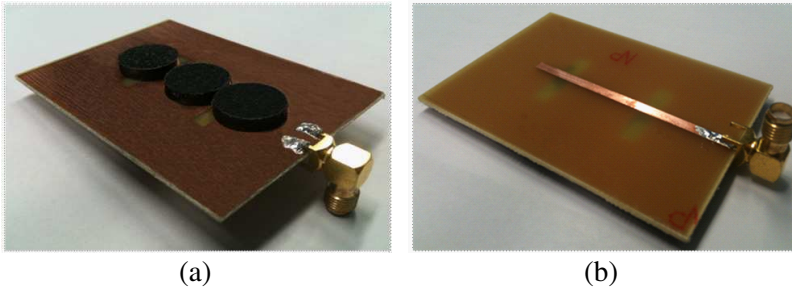

**Figure 2.** The fabricated design of the CDRA array. (a) Front view and (b) back view.

of the microstrip line ' $L$ ' is chosen so that its reactance cancels out that of the aperture slot, and it can be calculated by using the expression found in [5]:

$$L = \frac{\lambda_g}{4} \quad (3)$$

where:

$\lambda_g$  guided wavelength calculated by using Equation (2).

The simulated and fabricated design of this array has successfully covered the 5.0 GHz band, which is in good agreement with the theoretical frequency calculated using (1). The CDRA array resonates at a frequency of 5.1 GHz when elements are placed on the top of aperture slots. The fabricated geometry of this array antenna is depicted in Figure 2.

The lumped model circuit can be used to predict the return loss behavior of the antenna as mentioned in [3]. Recently, Ain et al. [10], presented the equivalent lumped element circuit of novel four elements aperture coupled rectangular shaped DRA array. This RDRA array design does not include the coupling between the array element because wideband behavior is not required. In our proposed equivalent lumped element circuit, mutual coupling is also introduced with aperture coupled CDRA array. This lumped element circuit is depicted in Figure 3. It can be categorized as follows:

- A and B represents the RLC blocks of aperture coupled first and last element of CDRA array respectively.
- C represents the middle CDRA RLC block which is excited using mutual coupling of the other two elements.
- D and E represent the mutual coupling blocks.
- F represents the microstrip line block.

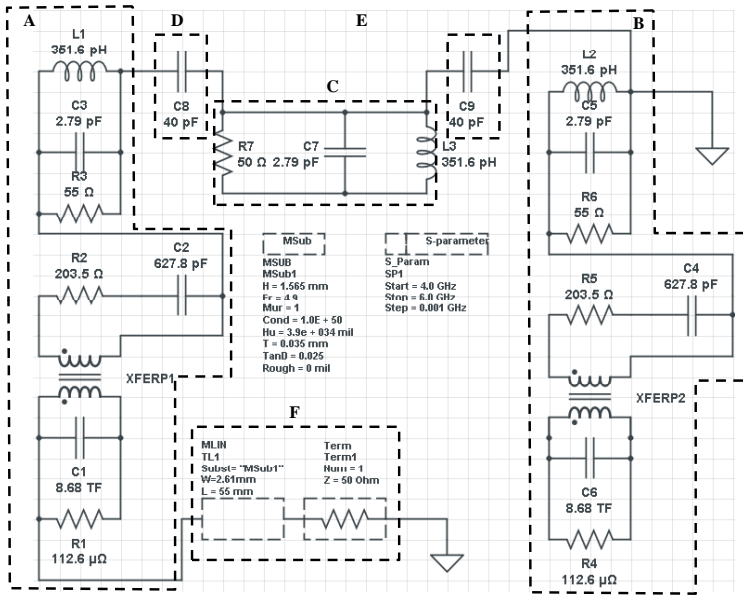

**Figure 3.** The cylindrical dielectric resonator antenna array RLC model.

The coupling capacitor blocks (i.e., D and E) represent the mutual coupling effect, which excites the middle CDRA. The Matlab programs have been developed to determine the lumped RLC elements by applying several equations obtained from [13]. The comparison between return loss results of CST, ADS and the fabricated design show very good agreement. The importance of mutual coupling capacitor in this proposed array is also analyzed in the results and discussion section.

### 3. RESULTS AND DISCUSSIONS

The aperture and mutual coupled 3-element CDRA array fed through the microstrip line is designed and fabricated to operate at 5.0 GHz band for 802.11a system applications. Figure 2(a) shows the final fabricated design consists of CDRA's made of CCTO ( $\text{CaCu}_3\text{Ti}_4\text{O}_{12}$ ) dielectric material, whose dielectric constant; height and diameter are 55, 3.0 and 15.5 mm respectively. The E8363C PNA vector network analyzer is used to measure the return loss ( $S_{11} < -10$  dB) of fabricated design. From the Figure 4, it is clear that the return loss

( $S_{11}$ ) results of measured and simulated design of antenna array are in good agreement. Over the entire 5.0 GHz band the return loss ( $S_{11}$ ) coefficients are below  $-10$  dB for both the measured and simulated results.

The achieved bandwidth from the simulated (CST and ADS) and measured antenna array is 1.076 GHz (21.2%), 1.0 GHz (19.6%) and 0.94 GHz (17.5%) respectively. The ADS return loss results with and without including coupling are also depicted in Figure 5. It is analyzed that without including the coupling effects the return loss behavior of this proposed array cannot be completely analyzed.

The differences in the simulated and measured results are due to the fabrication losses (i.e., placement of the elements on the fabrication board and the surface of the CDRA is not smooth which introduces the air gap between the DRA and the ground plane). The achieved directivity of this proposed array antenna varied from 7.33 to 10.5 dBi

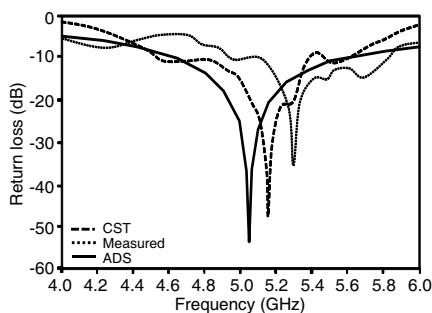

**Figure 4.** The comparison between the simulated and measured return loss ( $S_{11}$ ).

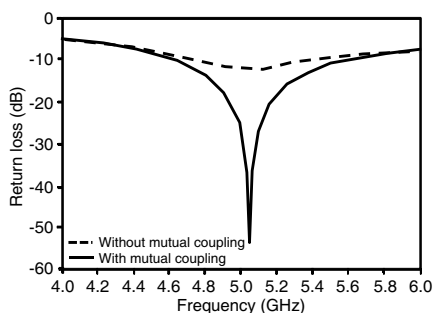

**Figure 5.** The comparison between the ADS return losses.

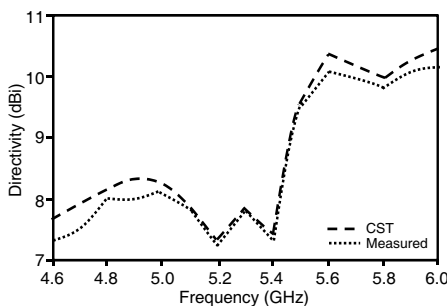

**Figure 6.** Antenna array directivity versus frequency.

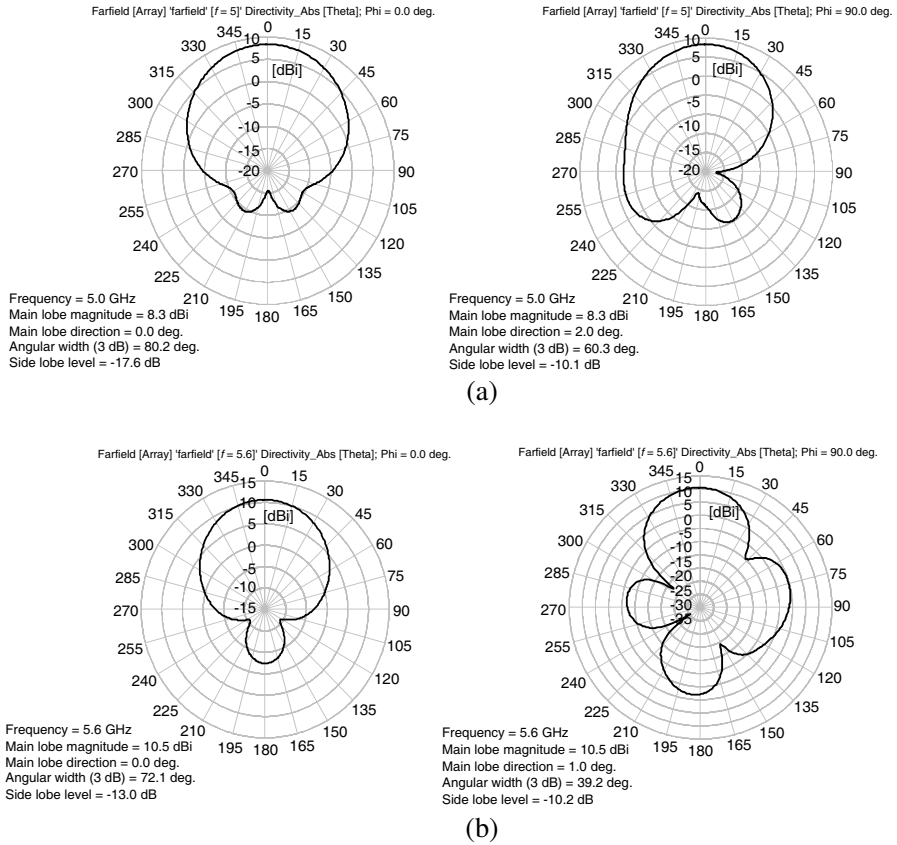

**Figure 7.** *E*-plane and *H*-plane radiation patterns at (a) 5.0 and (b) 5.6 GHz.

over the entire band from 4.6 to 6.0 GHz as depicted in Figure 6. The maximum directivity of 10.5 dBi is achieved at operating frequencies of 5.6 GHz.

The *E*-plane ( $\Theta = 0^\circ$ ) and *H*-plane ( $\Theta = 90^\circ$ ) radiation patterns of the proposed antenna array at 5.0 and 5.6 GHz respectively are depicted in the Figure 7. The corresponding magnitudes of main lobes in *E*-plane are 8.3 and 10.5 dBi respectively in the directions of the  $0^\circ$ . The corresponding *H*-plane radiation patterns at 5.0 and 5.6 GHz are depicted in the Figures 7(a) and (b). This proposed array radiates very small energy in the backward direction with front-to-rear ratio of 26 dB at central frequency of 5.0 GHz. The results show that the proposed antenna array is directional.



The simulated results for side lobe levels using two and three aperture slots are depicted in Figure 8. The side lobe levels with two and three aperture slots are  $-17.6$  and  $-12.4$  dB respectively at 5.0 GHz. It is observed that by using the mutual coupling mechanism for an additional third slot in this proposed array; not only increases the bandwidth and gain but also reduces the side lobe levels for whole

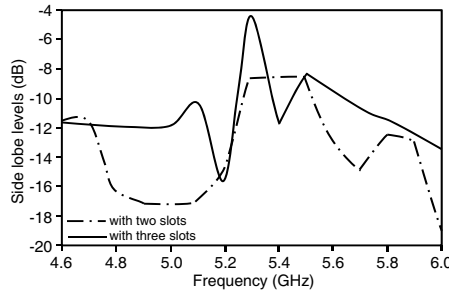

**Figure 8.** A side lobe level comparison using two and three slots.

**Table 2.** Comparison between proposed work and previous literatures by using the microstrip feed line.

Published work	Frequency Band (GHz)	Number of Elements	Maximum Gain (dBi)
M. F. Ain et al. 2012 [10]	X-band	$1 \times 4$	9.0
Chyrh, et al. 2011 [14]	5.0	$4 \times 2$	13
M. F. Ain et al. 2010 [15]	5.0	$3 \times 3$	10.0
<b>Proposed Work</b>	<b>5.0</b>	<b><math>1 \times 3</math></b>	<b>10.5</b>
Published work	Bandwidth (GHz)	Feeding method	—
M. F. Ain et al. 2012 [10]	0.042	Aperture	—
Chyrh, et al. 2011 [14]	0.6	Direct (patch antenna)	—
M. F. Ain et al. 2010 [15]	0.08	Aperture	—
<b>Proposed Work</b>	<b>1.076</b>	<b>Aperture</b>	—

5.0 GHz band. The proposed antenna achieved a maximum gain of 10.5 dBi and bandwidth of 1.076 GHz, which are 96.1% and 14.3% respectively more than the recent proposed work of Ain et al. [10]. Table 2 shows a comparison between the previous literatures and the proposed array presented in this paper.

#### 4. CONCLUSION

In this paper, a 3-element CDRA array at 5.0 GHz band is designed and presented. The aperture and mutual coupling techniques are used to excite the radiating elements. The maximum achieved directivity and bandwidth are 10.5 dBi and 1.076 GHz. Significant improvement in terms of bandwidth and gain is obtained as compared to recently reported work in the literature. The modeled equivalent lumped element circuit validates antenna performance and presents clear advantages over previously known antenna structures.

#### ACKNOWLEDGMENT

The authors would like to thank Universiti Teknologi PETRONAS in particularly Research and Innovation Office (RIO) in providing short term internal research fund for this study.

#### REFERENCES

1. Sharma, A. and S. C. Shrivastava, "Bandwidth enhancement techniques of dielectric resonator antenna," *International Journal of Engineering Science and Technology*, Vol. 3, Jul. 7, 2011.
2. Long, S., et al., "The resonant cylindrical dielectric cavity antenna," *IEEE Transactions on Antennas and Propagation*, Vol. 31, 406–412, 1983.
3. Luk, K. M. and K. W. Leung, *Dielectric Resonator Antennas*, Research Studies Press Ltd., Baldock, Hertfordshire, England, 2003.
4. Huang, Y. and K. Boyle, *Antennas: From Theory to Practice*, John Wiley & Sons, Ltd., 2008.
5. Petosa, A., *Dielectric Resonator Antennas Handbook*, Artech House, 2007.
6. Yau, D. and M. V. Shuley, "Numerical analysis of an aperture coupled rectangular dielectric resonator antenna using a surface formulation and the method of moments," *IEE Proceedings — Microwaves, Antennas and Propagation*, Vol. 146, 105–110, 1999.

7. Sreekantan, S., Y. K. Ling, Z. A. Ahmad, M. F. Ain, M. A. Othman, and S. I. S. Hassan, "Simulation and experimental investigations on rectangular, circular and cylindrical dielectric resonator antenna," *Progress In Electromagnetics Research C*, Vol. 7, 151–166, 2009.
8. Lin, C.-H., G.-Y. Chen, J.-S. Sun, K.-K. Tiong, T.-H. Peng, Y.-H. Chen, and Y. D. Chen, "Cylindrical DR antenna design," *PIERS Proceedings*, 329–330, Beijing, China, Mar. 23–27, 2009.
9. Raggad, H., M. Latrach, T. Razban, and A. Gharsallah, "Cylindrical dielectric resonator antenna fed by a stair slot in the ground plane of a microstripline," *2011 XXXth URSI General Assembly and Scientific Symposium*, 1–4, 2011.
10. Ain, M. F., Y. M. A. Qasaymeh, Z. A. Ahmad, M. A. Zakariya, M. A. Othman, S. S. Olokede, and M. Z. Abdullah, "Novel modeling and design of circularly polarized dielectric resonator antenna array," *Progress In Electromagnetic Research C*, Vol. 28, 165–179, 2012.
11. Ahmed, O. and A.-R. Sebak, "Mutual coupling effect on ultrawideband linear antenna array performance," *International Journal of Antenna and Propagation*, Vol. 2011, Artical ID 142581, 11 pages, 2011.
12. Mongia, R. K. and P. Bhartia, "Dielectric resonator antennas — A review and general design relations for resonant frequency and bandwidth," *International Journal of Microwave and Millimeter-Wave Computer-Aided Engineering*, Vol. 4, No. 3, 230–247, 1994.
13. Collin, R. E., *Foundations for Microwave Engineering*, 2nd Edition, Wiley-IEEE Press, 2000.
14. Chang, D.-C. and S.-H. Yen, "High gain antenna array with finite ground plane for IEEE802.11a WiFi application," *2011 IEEE International Workshop on Electromagnetics, Applications and Student Innovation (iWEM)*, 125–129, 2011.
15. Ain, M. F., Y. M. A. Qasaymeh, Z. A. Ahmad, M. A. Zakariya, M. A. Othman, A. A. Sulaiman, A. Othman, S. D. Hutagalung, and M. Z. Abdullah, "A novel 5.8 GHz high gain array dielectric resonator antenna," *Progress In Electromagnetics Research C*, Vol. 15, 201–210, 2010.